



KIOTI

CK2610/3510/4010

KIOTI TRACTOR

Owner's Manual

MAJOR MAINTENANCE ITEMS

CHECKING INTERVAL (Run Hours)	CHECK AND MAINTENANCE ITEMS	REMARKS
Initial 50 hours	Engine oil and Engine oil filter (DI / IDI engine), Transmission oil filter, HST filter	Replace
	Clutch pedal play, Brake pedal play, Fan belt tension, Greasing, Wheel bolt torque	Check
	Transmission oil level, Front axle oil level, Coolant level, Air cleaner element	Check
Daily check	Radiator grill cleaning, Engine air filter, Seat belt	Check
	Tire inflation pressure and damage, Parking brake condition	Check
	PTO shaft and Guard condition, 3 point hitch and Draw-bar condition with secure pins	Check
Every 100 hours	Engine oil and Engine oil filter, Clutch pedal play, Brake pedal play, Fan belt tension and condition, Engine air hose and clamp, Fuel line and clamp	Check
Every 200 hours	Transmission oil filter, HST filter, Fuel filter	Replace
	Radiator hose line and clamp, Toe-in, Air cleaner filter	Check
Every 250 hours	Engine oil and Engine oil filter (Tier2 or 3 engine)	Replace
Every 400 hours	Transmission oil, Front axle oil, Engine oil and Engine oil filter (Tier4 engine)	Replace
Every 800 hours	Engine intake and exhaust valve	Adjust
Every 1,000 hours	Coolant	Replace
Every 1 year	Air-con filter, Engine air filter, Engine oil and Engine oil filter	Replace
Every 2 years	Coolant	Replace

※ Using unspecified parts or oil and fuel with poor quality can damage the tractor seriously.

※ For detailed maintenance interval and procedures, refer to "Service" in chapter 7.

FOREWORD

Congratulations, and welcome to the fabulous world of **CK2610(H) / CK3510(H) / CK4010(H,F,HF)** ownership, where serious work is made fun again!

This versatile tractor is a culmination of the entire tractor and diesel engine knowledge gained by the **Dae-dong Industrial Co.,LTD** over the years since 1947. The **CK2610(H) / CK3510(H) / CK4010(H,F,HF)** and has been designed with the finest materials and under rigid quality control standards set forth by the **KIOTI Engineering Department**.

Knowledge of tractor operation is essential for many years of dependable service and reliability. To help new owner's familiarize themselves with the **KIOTI CK2610(H) / CK3510(H) / CK4010(H,F,HF)**, it is the policy of **KIOTI tractor** to provide an owner's manual which includes helpful information about tractor safety, operation and maintenance. If the information you seek is not found in this manual, your **KIOTI tractor dealer** will be happy to help you.

Please feel free to contact **DAEDONG IND. CO.,LTD** with your questions/concerns.

< NOTE >

- Make sure to read this manual carefully and keep it handy for future reference.
- When leasing or transferring this tractor, deliver this manual together with the tractor.
- The specifications in this manual are subject to change without notice.

ISO 3600 EU STANDARDS

This manual was compiled in compliance with the ISO 3600, standards and the instructions contained here comply with the requirements of the Machinery Directive 2010/52/EU in force in the European Community. For tractors sold or used outside the European Community, local laws will prevail.

Main protections on the tractors discussed in this manual.

DESCRIPTION	NON CABIN	CABIN
1. ROPS (Protection against overturning)	Yes	Yes
2. FOPS (Protection against objects falling from above)	No	Yes (1365J)
3. OPS (Protection against penetration of objects from sides) protection against hazardous chemicals	No (Category I)	No (Category I)

TABLE OF CONTENTS

■ FOR SAFE OPERATION	1
■ BEFORE OPERATION	2
■ SPECIFICATIONS.....	3
■ FUNCTION DESCRIPTION AND OPERATING TIPS....	4
■ OPERATION	5
■ 3-POINT HITCH IMPLEMENT AND LOADER OPERATION ..	6
■ MAINTENANCE.....	7
■ STORAGE AND DISPOSAL.....	8
■ TROUBLESHOOTING.....	9
■ INDEX.....	10

TABLE OF CONTENTS

FOR SAFE OPERATION	1-1	WHEN USING LOADER.....	1-34
SAFETY PRECAUTIONS	1-2	SAFETY DECAL MAINTENANCE	1-37
GENERAL PRECAUTIONS.....	1-2	DECAL MOUNTING LOCATION	1-37
SERVICE INSPECTION AND CLEANING	1-7	DESCRIPTION.....	1-39
SAFETY PRECAUTIONS FOR TRACTOR USE....	1-13	CAUTIONS FOR DECAL MAINTENANCE	1-43
STARTING THE ENGINE.....	1-13	BEFORE OPERATION	2-1
INSTALLING AND OPERATING IMPLEMENT.....	1-15	VEHICLE IDENTIFICATION NUMBER.....	2-2
DRIVING.....	1-21	PRODUCTION SERIAL NUMBER	2-2
DRIVING ON ROADS.....	1-24	ENGINE SERIAL NUMBER.....	2-2
DRIVING ON NARROW ROAD, BUMPY ROAD OR SLOPE	1-25	TRANSMISSION NUMBER.....	2-2
LOADING AND UNLOADING TO/FROM TRANSPORTING TRUCK.....	1-28	ESSENTIAL REPLACEMENT PARTS	2-3
WORKING IN FIELD	1-29	OILS AND FLUIDS	2-3
SAFETY PRECAUTIONS FOR STORAGE.....	1-30	FILTERS	2-4
AFTER DAILY WORK IS COMPLETED.....	1-30	BELTS AND RUBBER PARTS.....	2-4
FOR LONG-TERM STORAGE.....	1-31	OTHER COMPONENTS	2-5
SAFETY PRECAUTIONS FOR TRACTOR TRANSPORTATION	1-33	SPECIFICATIONS.....	3-1
		SPECIFICATIONS.....	3-2

TABLE OF CONTENTS

EXTERNAL DIMENSIONS	3-2	TACHOMETER/HOURMETER.....	4-12
MAJOR SPECIFICATIONS	3-4	ECO PTO.....	4-12
DRIVING SPEED TABLE.....	3-11	FUEL GAUGE.....	4-13
IMPLEMENT LIMITATIONS.....	3-13	ENGINE COOLANT TEMPERATURE GAUGE.....	4-13
STANDARD IMPLEMENT DIMENSIONS	3-13	WATER-IN-FUEL WARNING LAMP	4-14
FUNCTION DESCRIPTION AND		TURN SIGNAL LAMP	4-14
OPERATING TIPS	4-1	DPF REGENERATION WARNING LAMP	4-15
EXTERIOR VIEW.....	4-3	DPF REGENERATION UNDERWAY LAMP	4-15
SWITCHES	4-4	PTO INDICATOR.....	4-17
MOUNTING LOCATION	4-4	SINGLE BRAKE LIGHT	4-17
KEY SWITCH	4-5	ENGINE OIL PRESSURE WARNING LAMP	4-18
COMBINATION SWITCH	4-6	BATTERY CHARGE WARNING LAMP	4-19
HAZARD WARNING FLASHER SWITCH.....	4-8	PARKING BRAKE WARNING LAMP.....	4-19
DPF REGENERATION SWITCH.....	4-8	PREHEAT INDICATOR.....	4-20
SPEED CRUISE CONTROL SWITCH (OPTIONAL).....	4-10	LINKED PEDAL LAMP (OPTIONAL).....	4-20
INSTRUMENT CLUSTER.....	4-11	HST CRUISE LAMP (OPTIONAL).....	4-20
INSTRUMENT CLUSTER FEATURES	4-11	ERROR INDICATOR	4-21
		CONTROLS	4-22
		MAIN SHIFT LEVER.....	4-24
		RANGE SHIFT LEVER.....	4-24
		CLUTCH PEDAL	4-25

TABLE OF CONTENTS

BRAKE PEDAL.....	4-25	INITIAL OPERATION.....	5-2
PARKING BRAKE	4-26	OPERATING THE ENGINE	5-3
ACCELERATOR PEDAL	4-27	STARTING ENGINE	5-3
HAND THROTTLE LEVER.....	4-27	STOPPING ENGINE	5-7
DIFFERENTIAL LOCK PEDAL.....	4-28	WARMING UP	5-7
SEAT ADJUSTMENT.....	4-29	JUMP STARTING	5-8
POSITION CONTROL LEVER	4-30	OPERATING THE TRACTOR.....	5-9
LIFTING ARM (LOWER LINK) SPEED CONTROL KNOB.....	4-30	HOW TO DRIVE	5-9
PTO SHIFT LEVER	4-31	HOW TO FOLD ROPS	5-13
DOUBLE ACTING LEVER (OPTIONAL)	4-31	HOW TO RAISE ROPS TO UPRIGHT POSITION.....	5-15
LINKED PEDAL LEVER (OPTIONAL).....	4-32	PARKING.....	5-15
7-PIN SOCKET (OPTIONAL)	4-32	TURNING	5-17
TIRES	4-33	DRIVING ON SLOPE	5-17
INFLATION PRESSURE	4-35	PRECAUTIONS WHEN COMING IN AND OUT OF WORK FIELD	5-18
TREAD.....	4-36	PRECAUTIONS WHILE DRIVING ON THE ROAD	5-18
WHEEL TORQUE AND DIRECTION.....	4-38	LOADING INTO AND UNLOADING OUT OF THE TRUCK....	5-19
ADDITIONAL WEIGHT (OPTION).....	4-39	PRECAUTIONS WHEN USING POWER STEERING ..	5-20
HOW TO DRIVE.....	5-1	3-POINT HITCH CONTROL POSITION CONTROL	5-22
PRE-OPERATION CHECK.....	5-2	REMOTE HYDRAULICS	5-24

TABLE OF CONTENTS





3-POINT HITCH IMPLEMENT AND LOADER OPERATION	6-1	MAINTENANCE	7-1
REMOVAL AND INSTALLATION OF 3-POINT HITCH IMPLEMENT (INCLUDING CONNECTION OF UNIVERSAL JOINT).....	6-2	MAINTENANCE CHECK LIST	7-3
OPERATION FOR 3-POINT HITCH IMPLEMENT MOUNTING COMPONENTS	6-4	DAILY CHECK ITEM	7-3
ADJUSTMENT OF LIFT ROD	6-4	MAINTENANCE SCHEDULE CHART.....	7-4
ADJUSTMENT OF TOP LINK	6-5	LUBRICANTS	7-8
ADJUSTMENT OF CHECK LINK.....	6-5	MAINTENANCE CODE	7-9
DISMOUNTING THE IMPLEMENT	6-5	HOW TO DISCONNECT THE HOOD (A).....	7-9
HITCH (OPTIONAL) AND TRAILER.....	6-6	CHECKING AND ADDING FUEL (C)	7-9
INSTALLING PTO SHAFT	6-7	CHECKING TRANSMISSION FLUID LEVEL (D).....	7-10
HANDLING LOADER	6-9	CHECKING ENGINE OIL LEVEL (E)	7-11
FIXATION POINTS FOR FRONT END LOADER.....	6-10	CHECKING COOLANT LEVEL (F).....	7-12
DRIVING ON SLOPE	6-11	CLEANING RADIATOR GRILL AND SCREEN (G)	7-13
HYDRAULIC BLOCK.....	6-12	CHECKING BRAKE AND CLUTCH PEDALS (H)	7-14
		CHECKING GAUGES, METER AND INDICATORS (I)...	7-14
		CHECKING HEAD LIGHT, HAZARD LIGHT ETC. (J)...	7-14
		CHECKING SEAT BELT AND ROPS (K).....	7-14
		CHANGING ENGINE OIL AND REPLACING FILTER (L)..	7-14
		REPLACING TRANSMISSION FLUID AND FILTER (M)...	7-17
		CHANGING FRONT AXLE CASE OIL (N).....	7-18

TABLE OF CONTENTS

ADJUSTING BRAKE PEDAL (O)	7-19	MAIN FUSE (AP)	7-37
LUBRICATING GREASE NIPPLE (P)	7-21	REPLACING BULB (AQ)	7-38
CHECKING WHEEL BOLT/NUT TORQUE (Q)	7-22	STORAGE AND DISPOSAL	8-1
ADJUSTING CLUTCH PEDAL (R)	7-22	TRACTOR STORAGE	8-2
FUEL FILTER (S)	7-23	DAILY STORAGE	8-2
CLEANING AND REPLACING AIR CLEANER FILTER (T)....	7-23	LONG-TERM STORAGE	8-2
CHECKING FUEL LINES (U)	7-24	USING TRACTOR AFTER LONGTERM STORAGE.....	8-4
ADJUSTING FAN BELT TENSION (V)	7-25	USAGE AND DISPOSAL	8-4
BATTERY (W)	7-26	TROUBLESHOOTING	9-1
CHECKING INTAKE AIR LINE (X)	7-28	ENGINE TROUBLESHOOTING	9-2
ADJUSTING TOE-IN (Y)	7-28	TRACTOR TROUBLESHOOTING	9-4
CHECKING RADIATOR HOSE AND CLAMP (Z)	7-29	INDEX	10-1
POWER STEERING LINE (AA)	7-29		
ADJUSTING FRONT AXLE PIVOT PIN (AD)	7-30		
ADJUSTING ENGINE VALVE CLEARANCE (AE)	7-30		
REPLACING AIR CLEANER FILTER (AF)	7-30		
FLUSH COOLING SYSTEM AND CHANGING COOLANT (AJ)	7-31		
ANTI-FREEZE	7-33		
BLEEDING FUEL SYSTEM (AK)	7-34		
DRAINING WATER FROM CLUTCH HOUSING (AL) ...	7-35		
BODY FUSE (AN)	7-35		















SAFETY AND VEHICLE DAMAGE WARNING

This manual includes information titled as **WARNING**, **CAUTION**, **IMPORTANT** and **NOTE**. These titles indicate the following:

 WARNING	<p>This indicates that a condition may result in harm, serious injury or death to you or other persons if the warning is not heeded. Follow the advice provided with the warning.</p>
 CAUTION	<p>This indicates that a condition may result in damage to your vehicle or its equipment if the caution is not heeded. Follow the advice provided with the caution.</p>
 IMPORTANT	<p>This mark indicates emphasis on notable characteristics of working procedures, and information about technology for easier operation.</p>
 NOTE	<p>This indicates that interesting or helpful information is being provided.</p>

UNIVERSAL SYMBOLS

Various universal symbols have been used on the instruments and controls of your **KIOTI** tractor. Below is a list of the universal symbols and their meanings.

	Low Fuel Warning Light		QT lamp	H	High Temperature
	Coolant Temperature Warning Light		Preheat	C	Low Temperature
	Parking Brake		Headlight-High Beam		Water-In-Fuel warning lamp
	Battery Charging Condition	ECO	ECO PTO Lamp		DPF Warning Light
	Engine Oil Pressure		Single Brake Light		DPF Progress Light
	Turn Signal Light	N	N: Neutral Position	CRUISE PTO	Cruise PTO Warning Light
	Power Take-Off Clutch Control-On Position	F	Full		
	Four-Wheel Drive-ON	E	Empty		

FOR SAFE OPERATION

SAFETY PRECAUTIONS 1-2

- GENERAL PRECAUTIONS..... 1-2
- SERVICE INSPECTION AND CLEANING 1-7

SAFETY PRECAUTIONS FOR TRACTOR USE..... 1-13

- STARTING THE ENGINE..... 1-13
- INSTALLING AND OPERATING
IMPLEMENT..... 1-15
- DRIVING..... 1-21
- DRIVING ON ROADS..... 1-24
- DRIVING ON NARROW ROAD, BUMPY
ROAD OR SLOPE..... 1-25
- LOADING AND UNLOADING TO/
FROM TRANSPORTING TRUCK 1-28
- WORKING IN FIELD 1-29

SAFETY PRECAUTIONS FOR STORAGE..... 1-30

- AFTER DAILY WORK IS COMPLETED..... 1-30
- FOR LONG-TERM STORAGE..... 1-31

SAFETY PRECAUTIONS FOR TRACTOR TRANSPORTATION 1-33

WHEN USING LOADER..... 1-34

SAFETY DECAL MAINTENANCE 1-37

- DECAL MOUNTING LOCATION 1-37
- DESCRIPTION 1-39
- CAUTIONS FOR DECAL MAINTENANCE..... 1-43

PRECAUTIONS BEFORE OPERATION

GENERAL PRECAUTIONS

A careful operator is the best operator. Most accidents can be avoided by observing certain precautions. To help prevent accidents, use these safety precautions, and pay attention to the job at hand. If you can prevent an accident, your time will have been well spent.

The following should never be allowed to operate this machine.

- Those under the influence of alcohol
- Women that are pregnant.
- Those under 18
- Those without driver's license
- Those who are fatigued, sick or under the influence of medicine; others who are not qualified for certain reasons to operate this machine

Do not operate the machine with fatigue. Take a rest if necessary.

Otherwise, an unexpected accident can occur.

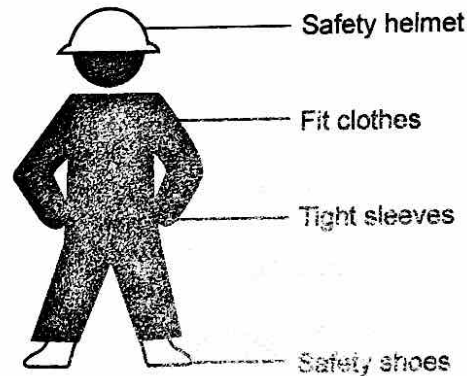

C56C101A

Please wear the appropriate working clothes.

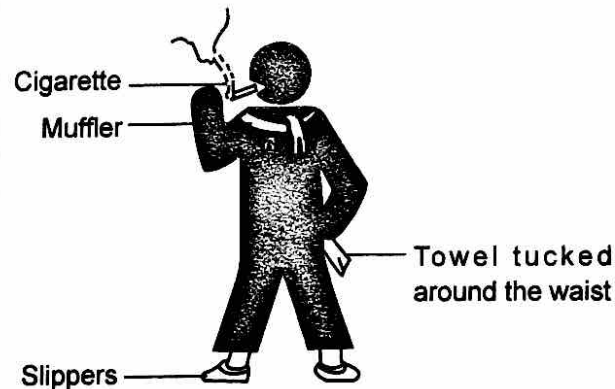

C56O102A

Otherwise, your clothes can be caught into rotating parts or you may slip, leading to an accident.



H61O440A

This tractor is basically designed for agricultural use or similar.

Use other than the specified cannot be covered by warranty. The manufacturer is not liable for any damage resulting from unauthorized use, and such action can lead to a dangerous situation to a user. Authorized use means complying with operation, service and repair standards set by the manufacturer.

This tractor should be operated, service and repaired by a well-trained and skilled technician who is also aware of accompanying danger.

It is necessary to follow any applicable accident prevention practices, general health and safety standards and traffic regulations. The manufacturer is not liable for any damage resulting from unauthorized modification.

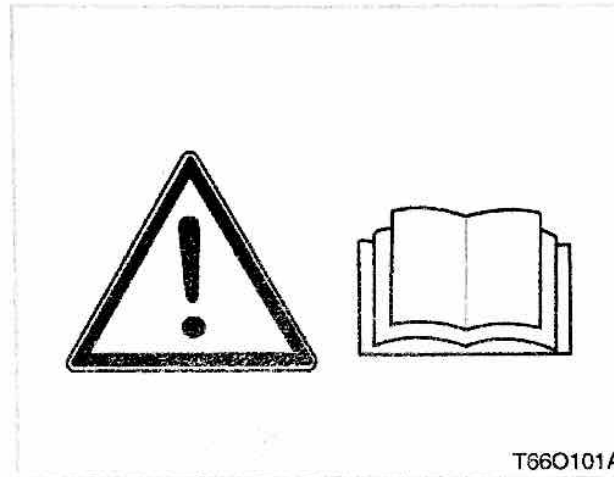

1. It is recommended that you read and understand this entire manual before operation of your new tractor. Failure to do so could result in accidents or injury.
2. Only persons who are properly trained should be allowed to operate the tractor.
3. Read and follow all warning labels and decals affixed to the tractor.
4. Replace any missing or damaged decals as soon as it is practical. A list of decals is shown on page 1-21~1-27.



5. Keep safety decals clean of dirt and debris.
6. Watch where you are going at all times so that you are able to avoid obstacles that can cause injury or damage to your tractor.
7. When starting the tractor make sure your path is clear of people to avoid accidents caused by sudden movements.
8. Before operating in reverse with your tractor, you should always check to see that the path is clear.

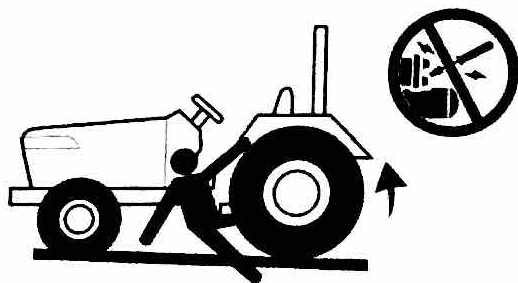

T66O103A

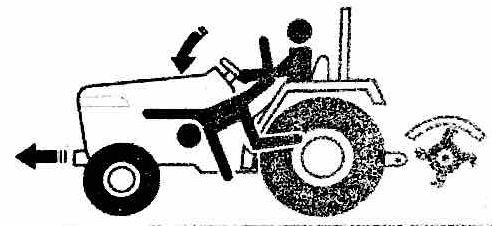

T66O104A

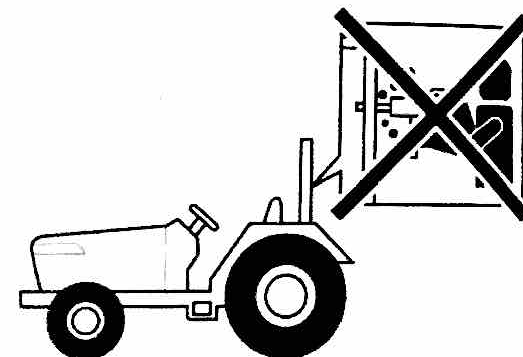

T66O105A

9. Never operate this tractor or any other agricultural equipment while under the influence of alcohol, drugs or while fatigued.
10. While working in cooperation with other tractors always communicate your intentions.
11. Do not start your tractor by shorting across the starter.
12. Never start the engine while standing on the ground.
13. Only the operator should ride on the tractor unless a passenger seat is installed. Keep bystanders away from the tractor while in operation.
14. When getting on and off the tractor, hand holds and step plates should always be used. This will help to prevent accidental slips trips and falls.
15. Be sure to scrape off mud or soil from your shoes before mounting the tractor.
16. All persons using the tractor should have knowledge of its proper operation and should read this manual carefully.
17. Never get off the tractor without setting the parking brake, lowering the implement to the ground and shutting of the tractor.
18. No modifications should be made to your **KIOTI** tractor.



T66O106A

19. Before starting your tractor you should depress the clutch and make sure that all shift levers are in the neutral position and parking brake is applied.

20. For your safety **ROPS** with a seat belt is recommended for all applications.

 **NOTE**

- Always use seat belt when the tractor is equipped with a **ROPS** and **CAB**. Never use the seat belt when tractor is not equipped with a **ROPS**. (**ROPS**: Roll-Over Protective Structures)

A **ROPS** and **CAB** should never be modified by welding, grinding or cutting, as this can weaken the **ROPS** structure. If any components of the **ROPS** unit are damaged, They must be replaced.

If the **ROPS** unit is removed or loosened for any reason, the parts should be fitted back to their original positions and all bolts should be properly torqued.

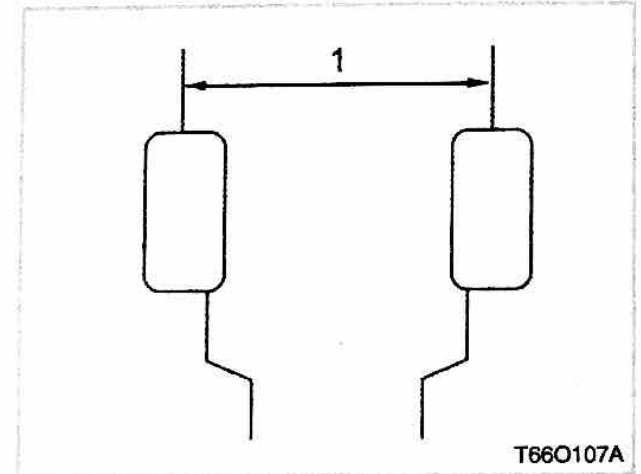

T66O107A

(1) Tread

21. Extra caution should be taken when driving tractors with narrow tread widths. For added stability you should adjust your rear wheel tread width, see page 4-36.

PRECAUTIONS DURING OPERATION

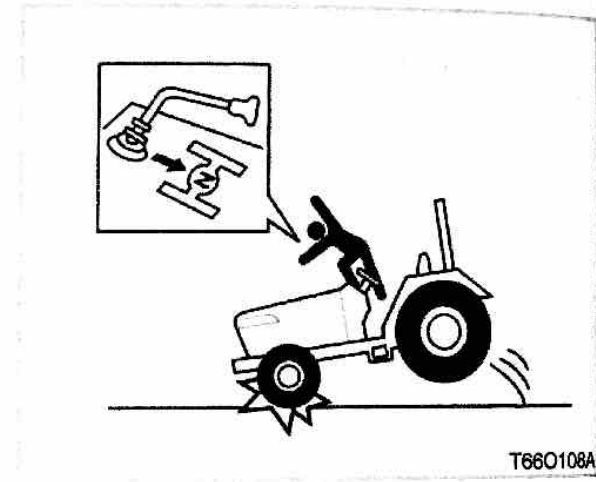
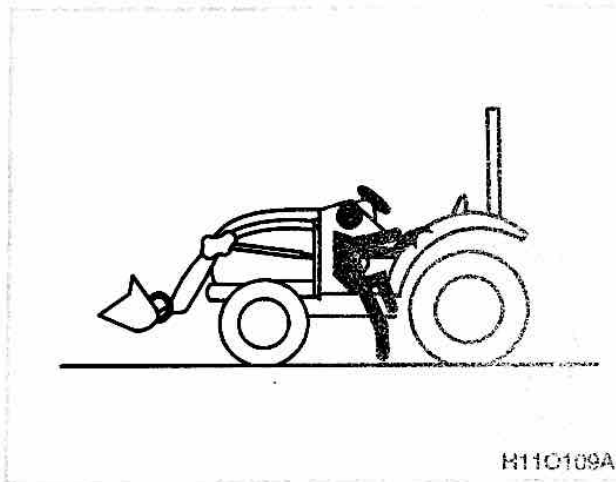
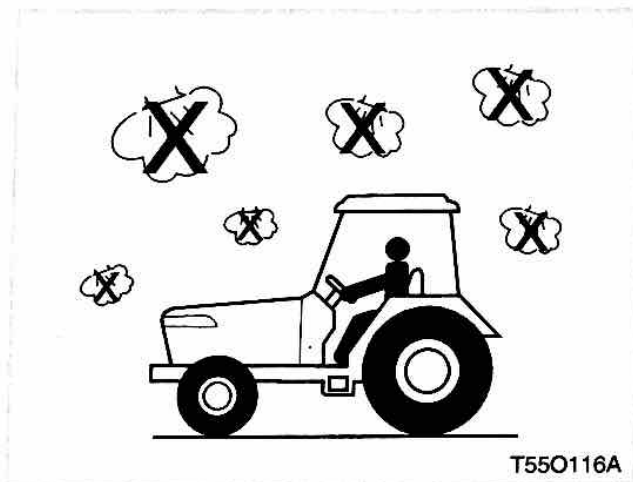

22. This cabin is not certified for chemical proof, never operate the tractor for chemical spray or in the air contaminated by any chemical or equivalent without approved personal safety equip; cartridge respiration/eyeprotection/gloves/etc.

1. Enter or leave the tractor leftward gripping hand rail on a fender.

⚠ WARNING

- ***Do not jump on or off the tractor. It may cause injuries. Always face the tractor, use the hand rails and steps, and get on or off slowly. Maintain a minimum three point contact to avoid falling. (Both hands on rails and one foot on the step, or one hand on the hand rail and both feet on the steps)***

2. Avoid accidental contact with gear shift levers while the engine is running. Unexpected tractor movements can result in bodily injury.



3. Do not park your tractor on a steep incline, and remember to shut off the engine and P.T.O before dismounting the tractor.

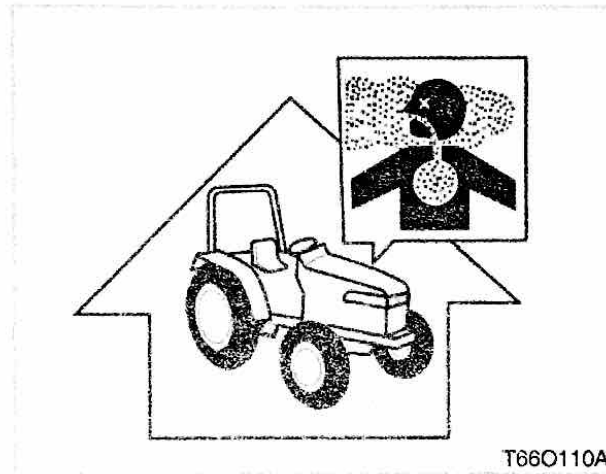

4. Do not operate your tractor in an enclosed building without the proper ventilation. Inhaling carbon monoxide can cause serious injury or death.

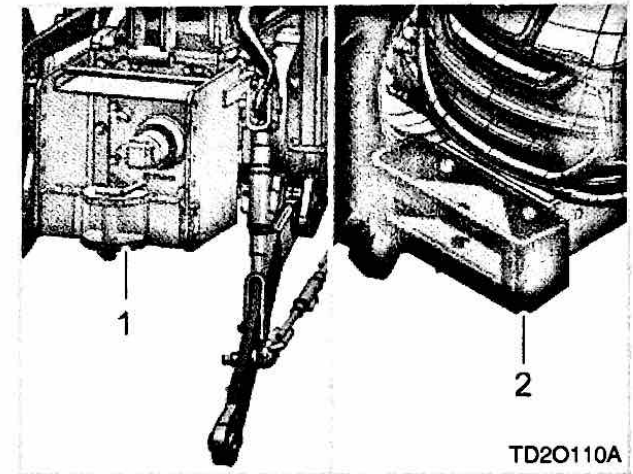

(1) Height Control Hitch

(2) Towing Hook

5. Make sure that all pressure lines are tight before starting the tractor.

6. Pull only from the hitch. Never hitch anything to the axle housing or any other point except the hitch. Pulling from any other location only increase the risk of serious personal injury or death.

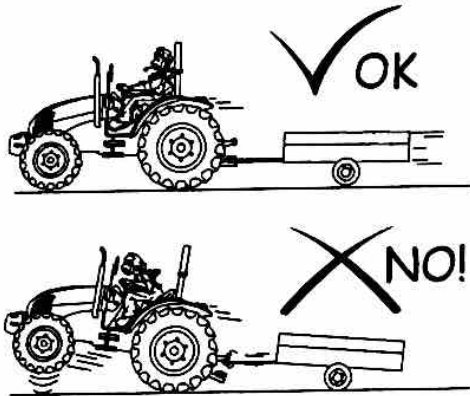

M55O117A

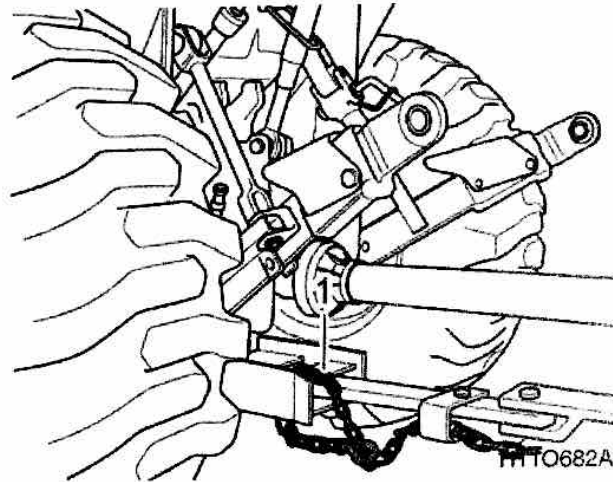

7. Improper use of the draw-bar, even if correctly positioned, can cause a rear overturn.
8. Do not overload an attachment or towed equipment. Use proper counterweights to maintain tractor stability. Hitch heavy loads to the draw-bar only.

9. Check for correct coupling between tow hook and trailer. See the Towing Attachments chapter.
10. Use ballast weight as recommended. Never add more ballast to compensate a higher load than allowed. Reduce load for safety.

11. A safety chain will help control drawn equipment should it be accidentally separated from the draw-bar while transporting. Using the proper adaptor parts, attach the chain to the tractor draw-bar support or other specified anchor locations. Provide only enough slack in the chain to permit turning. See your Dealer for a chain with a strength rating equal to, or greater than the gross weight of the towed equipment.



T66O112A

12. If the front of the tractor tends to rise up when heavy implements are attached to the three point hitch, weights should be installed on the front of tractor. Do not operate the tractor with a light front end.

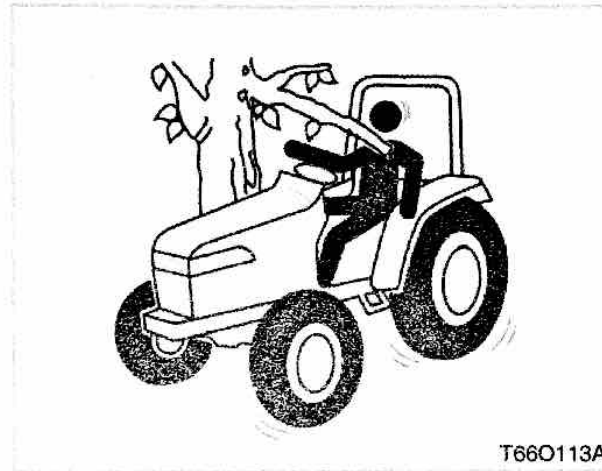

T66O113A

13. Always use the proper ballast weight on your tractor when using rear implements.
14. Watch front and rear to avoid obstacles at row ends, near trees and around other obstructions.

**WARNING**

- *Drive carefully to avoid injury from penetration of objects from sides, because this machine does not comply to OPS.*

15. Do not leave implements and attachments in the raised position when the vehicle is stopped or unattended.
16. When using implements or attachments with your tractor you should first read their respective owner's manual. You should always keep their safe operation procedures in mind.
17. You should be familiar with your equipment and its limitations.
18. If abused or used incorrectly your tractor can become dangerous to you and bystanders. Overloading your tractor or using unsafe equipment can also be dangerous and should be avoided. Refer to the "Specifications of Implement Limitation", which outlines the maximum load for safe tractor operation.

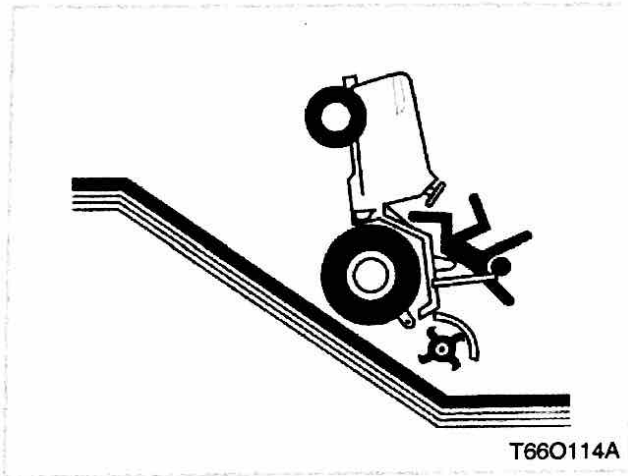

19. Driving forward out of a ditch or up steep inclines can cause the tractor to tip over backwards. To avoid this you should back out of these positions. Four wheel drive tractors can give you a false sense of security in the tractors ability to maneuver out of these positions, so extra caution should be taken.
20. Never try to get on or off a moving tractor.

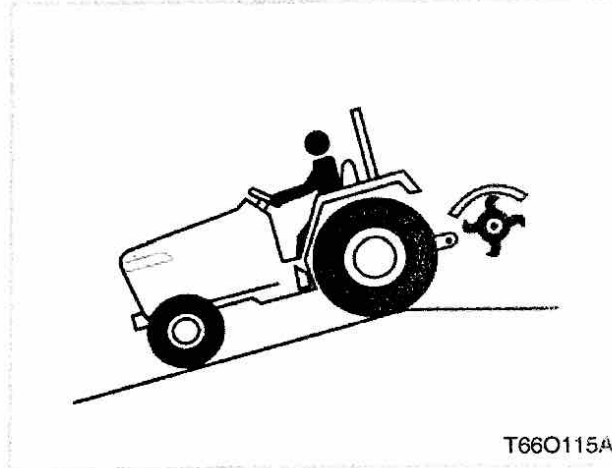

21. When working in groups, always let the others know what you are going to do before you do it.
22. Never "freewheel". Disengaging the clutch or shifting into neutral while descending a slope as this could lead to a loss of control.
23. Do not operate near ditches, holes, embankments, or other terrain features which may collapse under the tractor's weight. The risk of tractor upset is even higher when the ground is loose or wet.

WHEN DRIVING THE TRACTOR

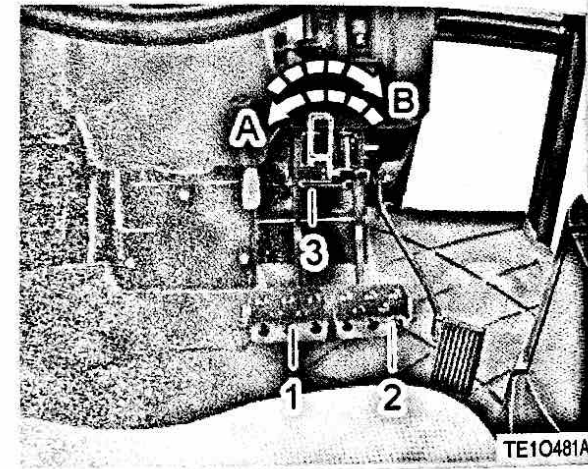

- (1) Brake Pedal (L) (2) Brake Pedal (R)
 (3) Brake Lock
 (A) Lock (B) Unlock

1. Lock the brake pedals together when traveling at road speeds. Brake both wheels together or at the same time when making an emergency stop. Uneven braking at road speeds could cause the tractor to tip over.



2. Always slow the tractor before turning. Turning at high speed may tip the tractor over or cause a loss of control.

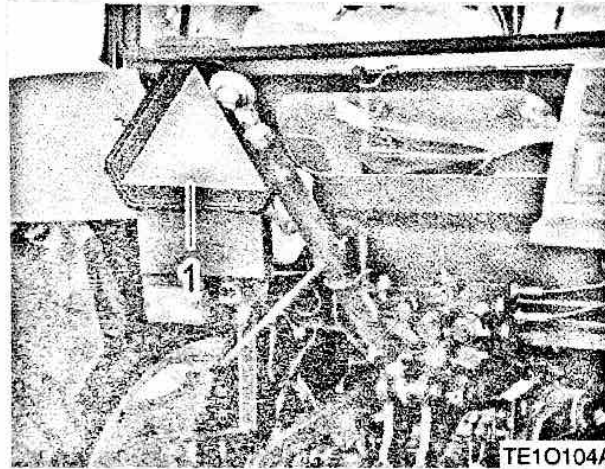

(1) SMV Emblem

3. Make sure that the Slow Moving Vehicle (SMV) sign is clean and visible. Use hazard lights as required.

4. Observe all local traffic and safety regulations.
5. Turn the headlights on. Dim them when meeting another vehicle.
6. Drive at speeds that allow you to maintain control at all times.
7. Do not apply the differential lock while traveling at road speeds. As the tractor may run out of control.
8. Avoid sudden movements of the steering wheel as this can cause a loss of control of the tractor. This risk is especially great when traveling at road speeds.
9. Do not operate an implement while the tractor is on the road. Lock the three point hitch in the raised position.
10. When towing other equipment, use a safety chain and place an SMV emblem on it as well.

WHEN PARKING THE TRACTOR

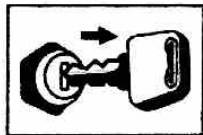
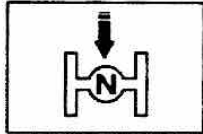

T66O120A

1. Disengage the P.T.O, lower all implements, place all control levers in the neutral position, set the parking brake, stop the engine and remove the key.

WHEN OPERATING THE P.T.O

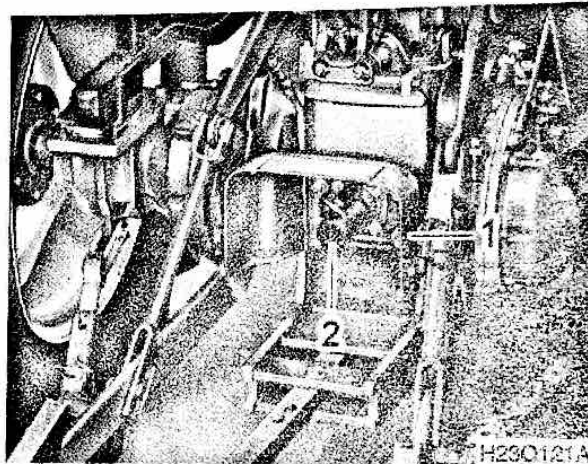

(1) P.T.O Shaft Cover (2) P.T.O Shaft Cap

1. Make sure the tractor is completely stopped, gears are in neutral and all moving components have completely stopped before connecting, disconnecting, adjusting, cleaning or servicing any P.T.O driven equipment.
2. Keep the P.T.O shaft cover in place at all times. Replace the P.T.O shaft cap when the shaft is not in use.

3. Before installing or using P.T.O driven equipment, read the manufacturer's manual and review the safety labels attached to the equipment.



WARNING

- *Before driving an implement through the PTO, always make sure that all bystanders are well away from the tractor.*
- *When using the PTO drive with a stationary tractor, always make sure that the gears are in neutral and that the parking brake is applied.*
- *Before starting up any PTO-driven implement hitched to the three-point linkage, lift the implement to its full height and check that at least 1/4 of the total length of the telescopic section of the drive shaft is engaged.*

⚠ WARNING

- **Ensure that implements and attachments are properly installed and that the tractor and implement PTO RPM ratings match.**

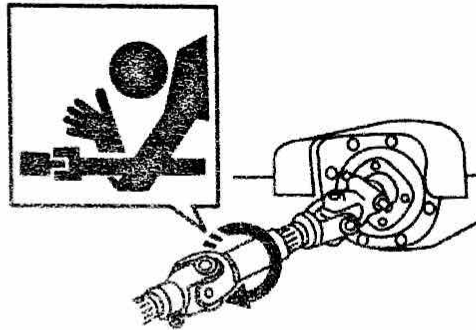

T66O122A

WHEN USING THE 3-POINT HITCH

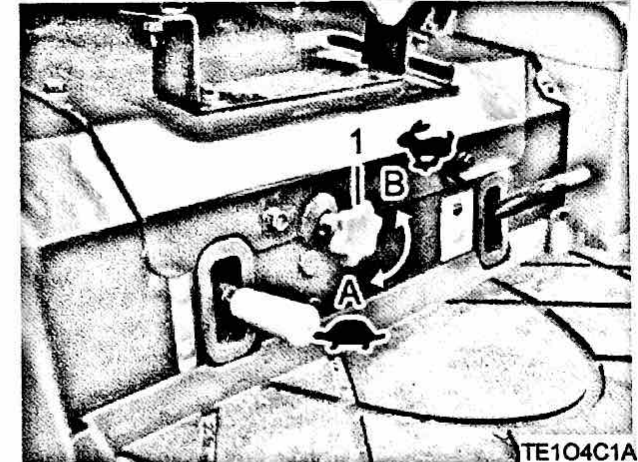

TE104C1A

- (1) 3-point Hitch Lowering Speed Knob
 (A) FAST (B) SLOW

4. When operating stationary P.T.O driven equipment, always apply the tractor parking brake and place chocks behind and in front of the rear wheels. Stay clear of all rotating parts.
5. Do not attach a PTO driven implement if the implements safety shields are damaged or not in place. Rotating shafts are an entanglement hazard.

1. Use the 3-point hitch only with equipment designed for 3-point hitch usage.
2. When using a 3-point hitch mounted implement, be sure to install the proper counterbalance weight on the front of the tractor.
3. When transporting on the road, set the implement lowering control in the "LOCK" position to hold the implement in the raised position.

SAFETY PRECAUTIONS DURING SERVICING



T66O124A



T66O125A

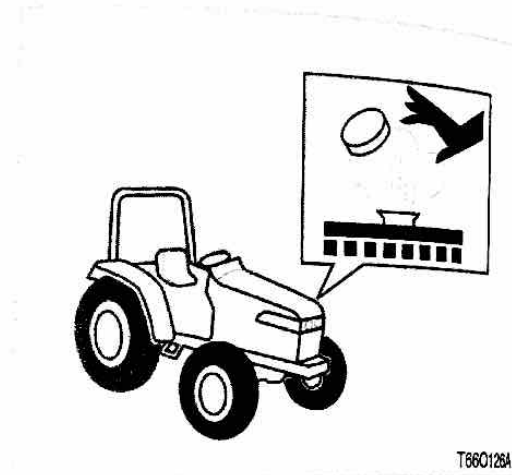

T66O126A

In order to service your tractor you must park it on a flat level surface, set the parking brake, place the gear shift lever in neutral and stop the engine.

1. Do not smoke while working around the battery or when refueling your tractor. Keep all sparks and flames away from the battery and fuel tank. The battery presents an explosive hazard because it gives off hydrogen and oxygen gas, especially when recharging.
2. Allow the tractor time to cool off before servicing any part that may have become hot while the tractor was running.
3. You must always stop the engine before refueling the tractor. Avoid overfilling the tractor or spilling the fuel.
4. Before jump starting a dead battery, read and follow all of the instructions.
5. It is recommended to keep a first aid kit and fire extinguisher handy at all times.
6. Do not remove the radiator cap while the coolant is hot. When cool, slowly rotate the cap to the first stop and allow sufficient time for excess pressure to escape. After all the pressure is released remove the cap completely. If your tractor is equipped with a coolant recovery tank, add coolant there rather than to the radiator.

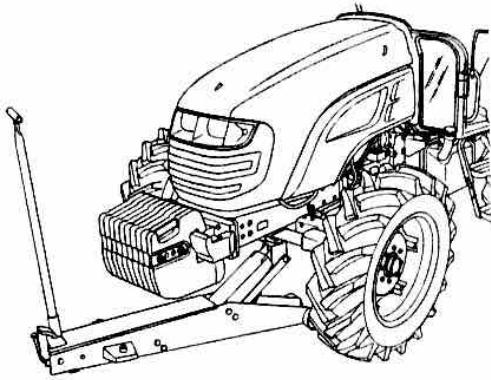

M55O114A

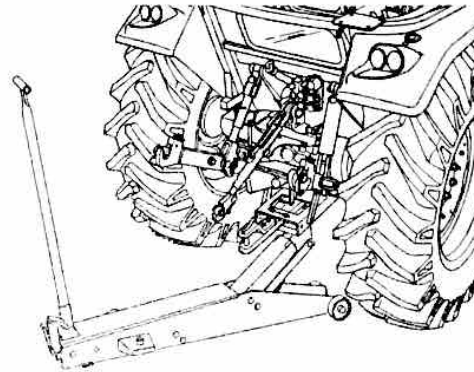

M55O115A

NOTE

- Apply the jack lift to the lifting points according to the type of operation and follow the safety procedures given before.

7. If the tractor must be lifted for servicing, take it to a suitably equipped workshop.
8. Carry out the following operations before any operation of the tractor: Engage the four-wheel drive, the first gear and the parking brake and put chocks to the wheels touching the ground.
9. Before lifting the tractor, prevent it from swinging by means of wooden wedges applied to the front axle.

10. Use floor jack of suitable capacity and apply them at the centre of the front and rear axles while paying due attention to weight distribution.
11. No decals for the lifting point are applied on the tractor, as they would be, too difficult to apply in the available spaces and would be all too easily removed or effaced during normal operation of the tractor.

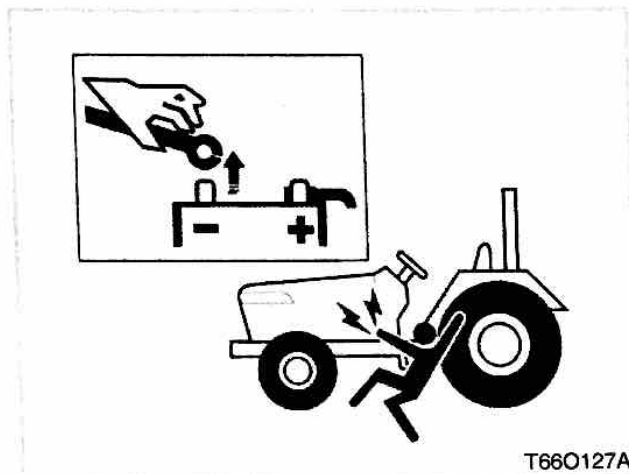

12. When working with your tractors electrical components you must first disconnect the battery cables.
13. To ensure that there are no accidents from sparks you must first disconnect the negative battery cable.

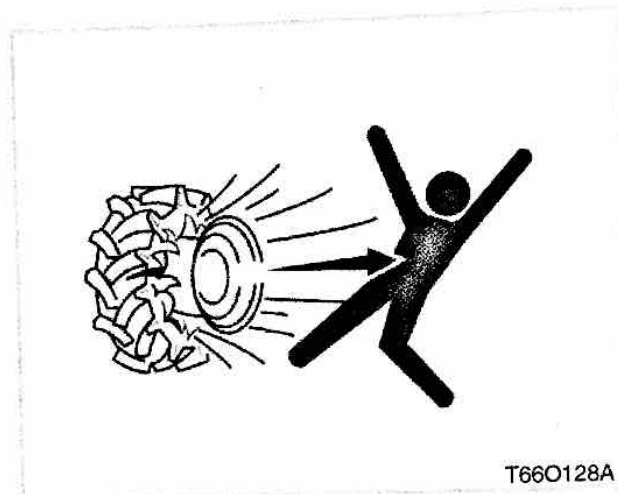

14. Tire mounting should be done by qualified professionals, with the proper equipment.
15. Maintaining correct tire pressure is important for the life of your tires.
Do not inflate the tires above the recommended pressure specified in the owner's manual.
16. Securely support the tractor when changing wheels or the wheel tread width.

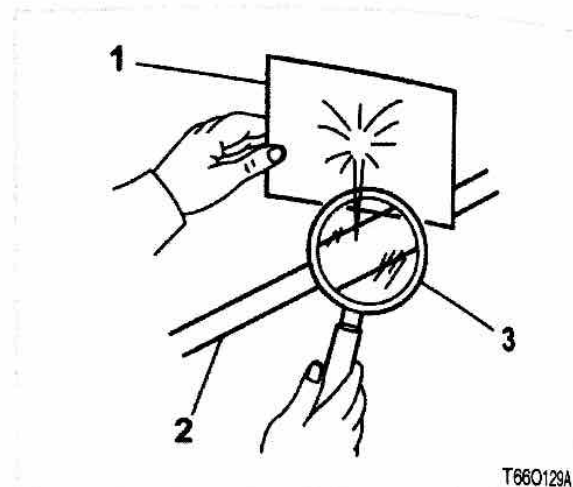

- (1) Cardboard
(2) Hydraulic Line
(3) Magnifying Glass

17. Make sure that wheel bolts have been tightened to the specified torque.
18. Leaking hydraulic fluid under pressure has sufficient force to penetrate skin, causing serious personal injury. Be sure to release all residual pressure. Before disconnecting hydraulic lines.

Before pressurizing to the hydraulic system, make sure that all connections are tight and that all line, pipes and hoses are free of damage.

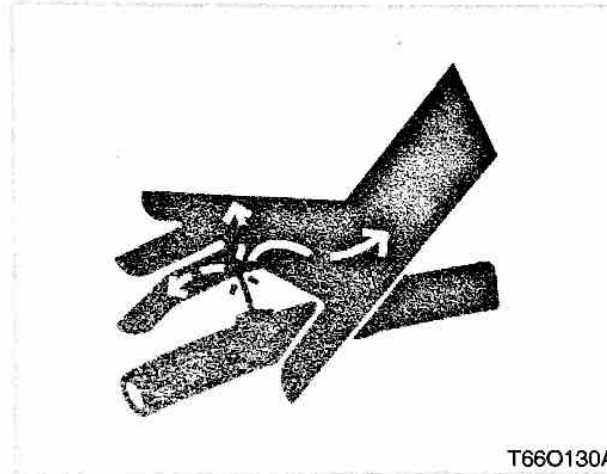

T66O130A

19. Fluid leaking from pinholes may be invisible. Do not use hands to search for suspected leaks; Use a piece of cardboard or wood, instead. Use of safety goggles or other eye protection is also highly recommended. If injured by escaping fluid, see a medical doctor at once. This fluid can produce gangrene and/or severe allergic reaction.

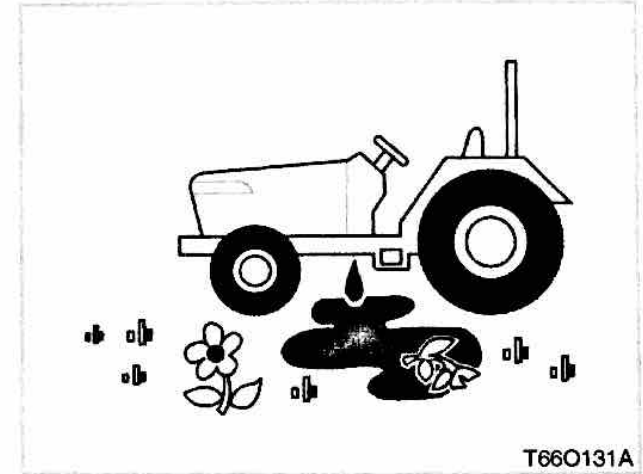

T66O131A

20. Keep environmental pollution in mind. When replacing coolant or oil, dispose properly. Be sure to observe all relevant regulations when you dispose of the engine oil, transmission oil, fuel, coolant, filters and battery.

SAFETY PRECAUTIONS WHEN USING THE LOADER

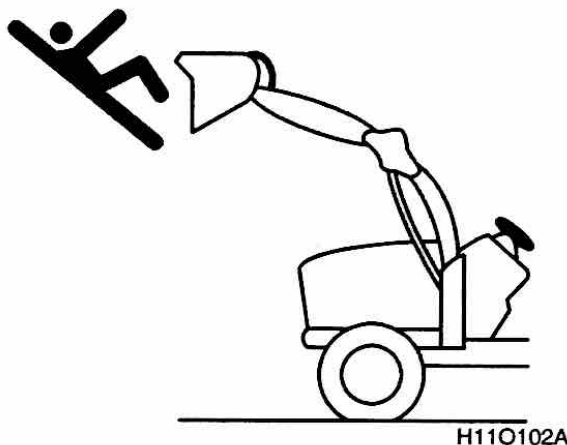

1. Never let anyone get in the loader and use the loader as a work-bench. Otherwise, it may lead to injury or even death.

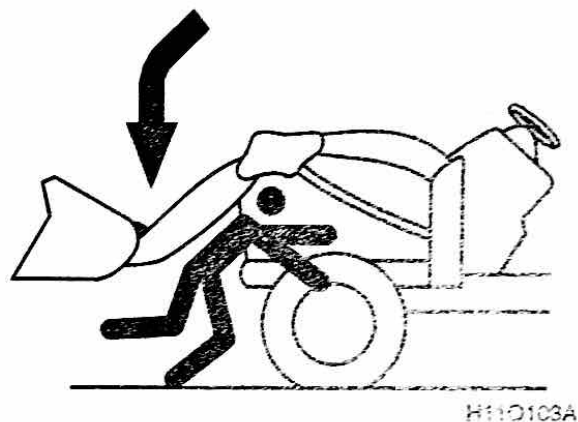

2. Do not stand under the lifted loader or get close to it. Also, lower the loader arm onto the ground before leaving the tractor. Otherwise, it may lead to a fatal injury or even death.

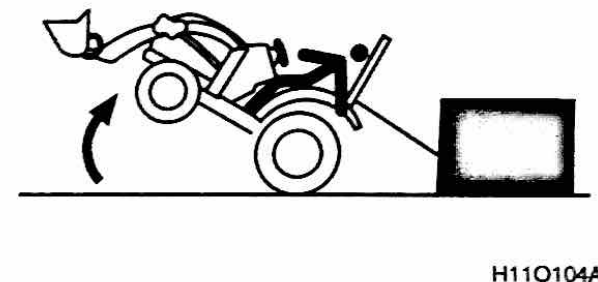

3. The loader can be turned over if a draw-bar is improperly loaded. Make sure to use a draw-bar proper for the 3-point hitch lower link. Otherwise, it may lead to an injury or even death.

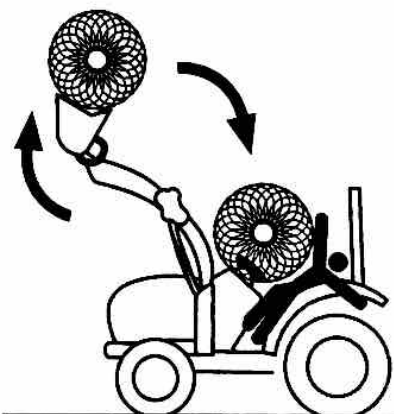

H110105A

4. Never carry a big object with the loader unless the correct implement is attached. Keep a carried object low during driving. Otherwise, it may lead to an injury or even death.

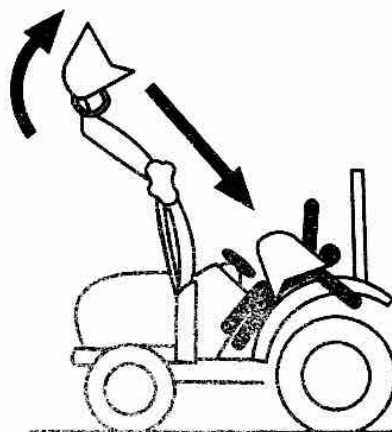

H110106A

5. When attaching or detaching the loader, fit parts which are connected to the bucket and boom. The bucket or boom can be accidentally dropped down, leading to an injury or even death.



H110107A

6. Do not allow loader arms or attachment to contact electrical power lines. Electrocution will cause serious injury or death.

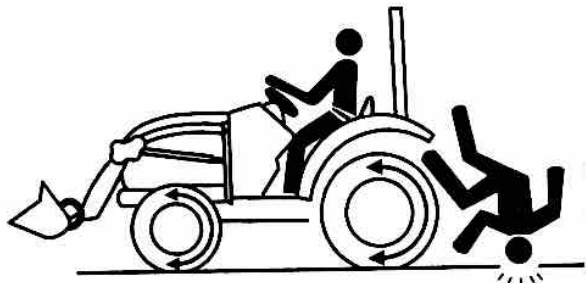

H11O108A



C56O185A

7. Keep bystanders away. No riders.

⊕ IMPORTANT

- **ROPS (Roll Over Protective Structure), sun canopy are not a FOPS (Falling Object Protective Structure).**

It never can protect the riders against falling objects.

Avoid driving the vehicle into a dangerous area such as falling rocks zone.

- **A CABIN(field option) is a FOPS except ROPS and Sun canopy.**

SAFETY DECAL MAINTENANCE DECAL MOUNTING LOCATION

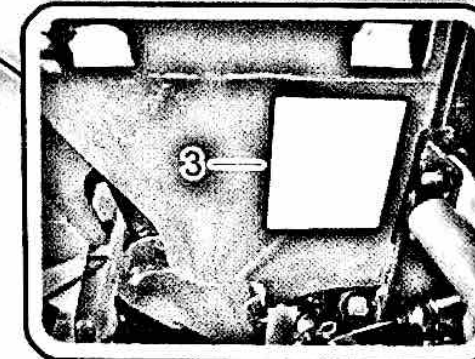
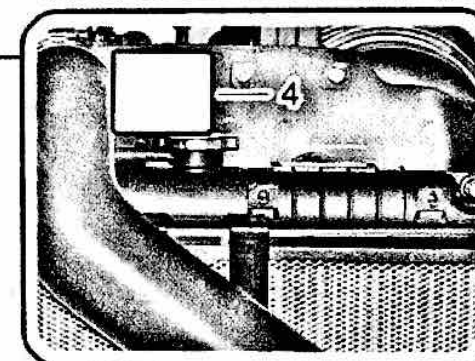
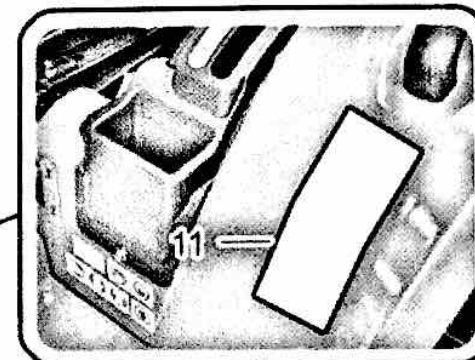
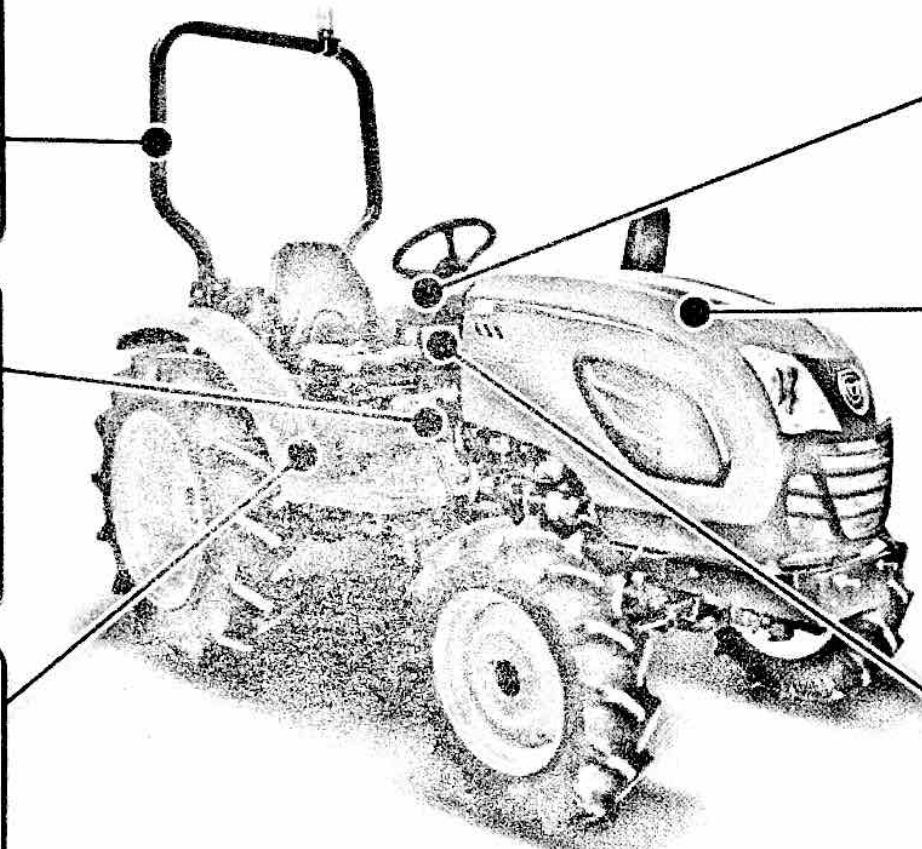
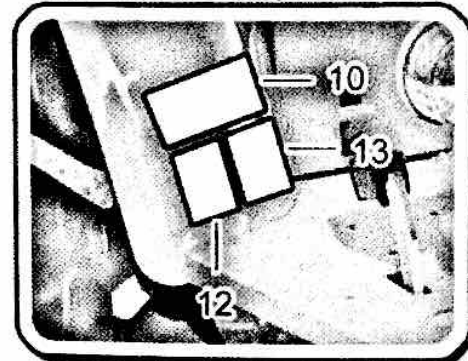
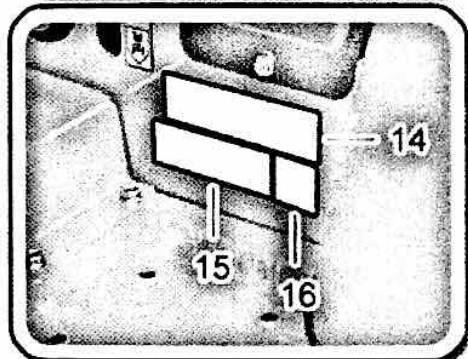
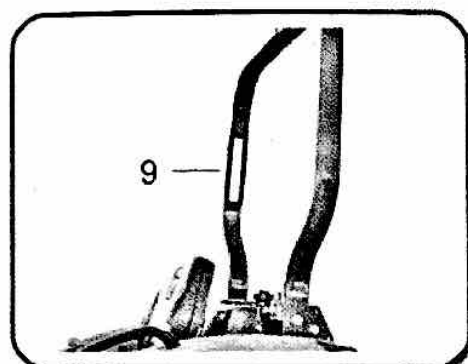

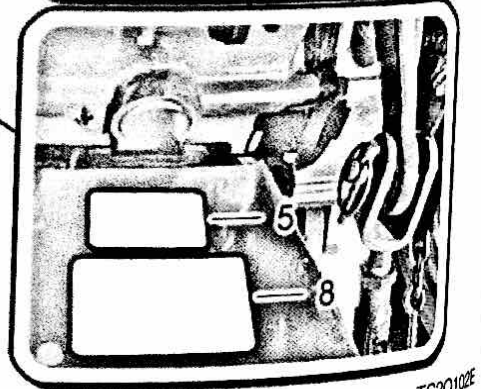
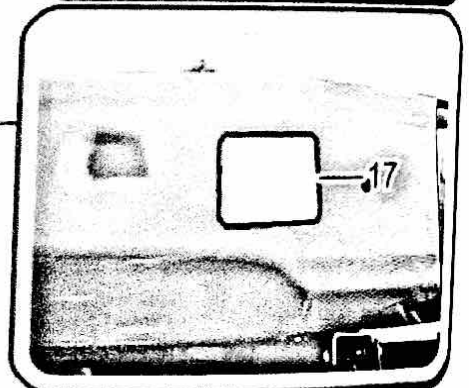
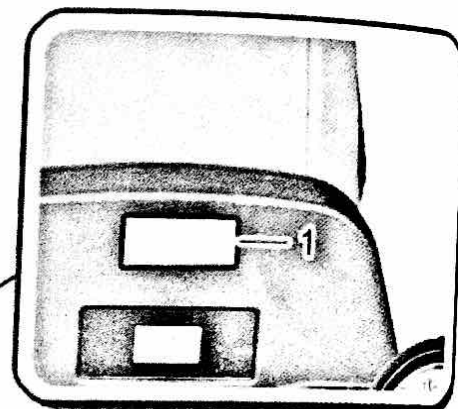
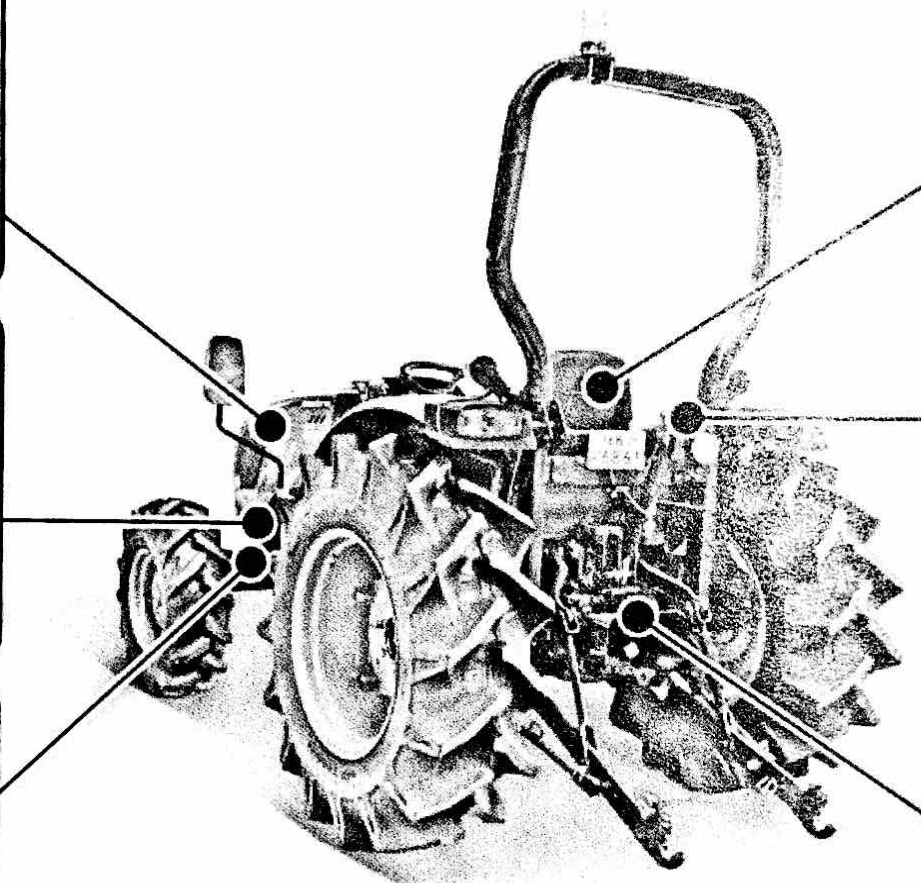
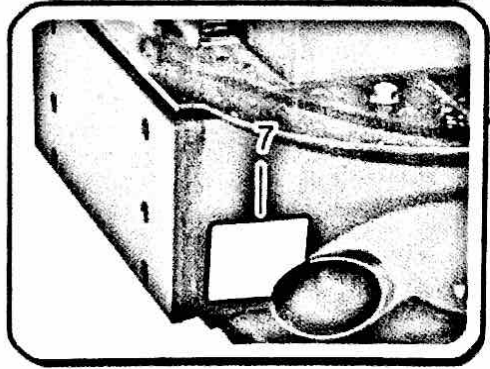
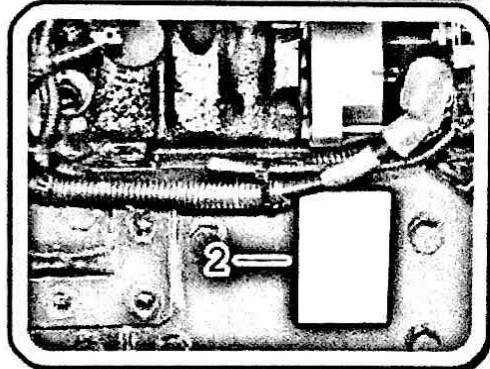
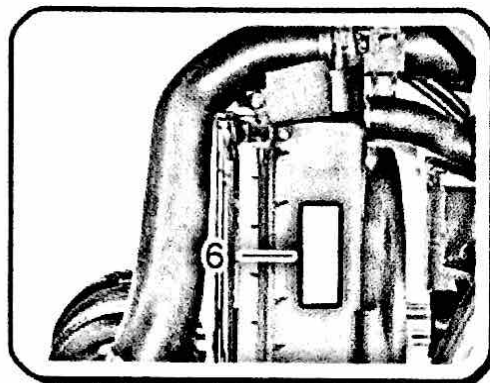

DESCRIPTION

(1) Part number: T2555-52611

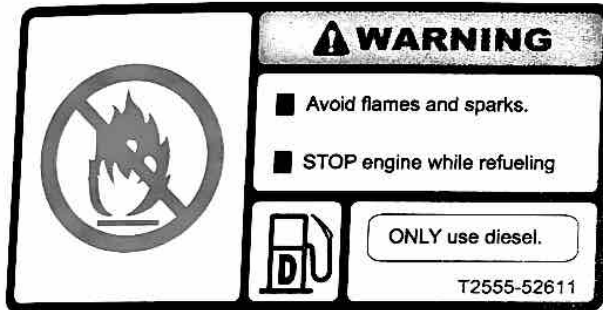

(2) Part number: T4938-53551



(3) Part number: T4938-52351



(4) Part number: T2555-52282



(5) Part number: T2615-52131(AU/TH)

(6) Part number: T4625-52351

(7) Part number: T2615-55112

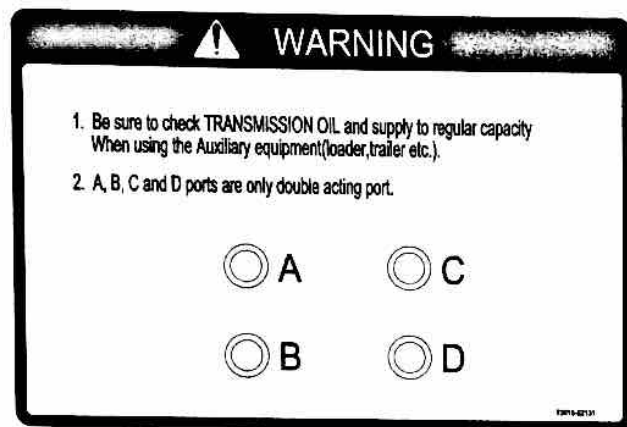

(8) Part number: T2555-52262

⚠ WARNING



To prevent accident during operation:

1. Implement that pulls or pushes objects should be attached only to the drawbar.
2. Implements that are designed to use the 3-point hitch should only use the 3-point hitch.

To prevent severe and deadly injuries during P.T.O. operation:

1. All protective components should be in place.
2. Do not let your hands, feet and clothes come near the implement.
3. When disengaging an implement from the P.T.O. stop the engine in advance. When repairing or servicing the tractor or its part, depress the brake pedal to set the parking brake. Also, make sure to chock the wheels when parking on a hill.

T2555-52262

(10) Part number: T4182-53191

⚠ WARNING

TO AVOID POSSIBLE INJURY, DEATH OR LOSS OF PROPERTY FROM A MACHINE RUNAWAY

- With the engine off, unexpected machine movement could result regardless of the gearshift position.
- Before dismounting the machine, apply the parking brake to prevent machine runaway.

T4182-53191

(9) Part number: T4555-52353

⚠ DANGER



- Improper operating of tractor can rollover or upset.
- DO NOT operate vehicle without raised ROPS and locking pins in position.
- DO NOT attach ropes or chains to ROPS for pulling.
- Lower the ROPS for low clearance ONLY.
 - DO NOT fold ROPS with a canopy attached
 - Seat belt is not recommended with ROPS lowered
 - NO protection is provided in lowered position.
- RAISE ROPS and insert locking pin immediately after low clearance use, or for transport.
- ALWAYS wear seat belt with ROPS in raised position. Failure to comply will result death or serious injury.



T2555-52353

(11) Part number: T2555-52141

⚠ WARNING

- Before starting and operating
 - Know the operating and safety instructions in the operators manual and on the tractor.
 - Clear the area of bystanders.
 - Locate and know operation of controls.
 - Fasten your seat belt.
- Start engine only from operators seat with transmission in neutral, PTO disengaged and hydraulic controls in lowered position.
- Slow down on turns, rough ground and slopes to avoid upset.
- Do not permit anyone but the operator to ride on the tractor, There is no safe place for riders.
- Lock brakes together, use warning lights and SMV emblem while driving on roads.
- Lower equipment, place gear shift levers in neutral, stop engine and apply parking brake before leaving tractor seat.
- Avoid accidental contact with rear shift lever while engine is running. Unexpected tractor movement can result.

FAILURE TO FOLLOW ANY OF THE INSTRUCTIONS ABOVE CAN CAUSE SERIOUS INJURY TO THE OPERATOR OR OTHER PERSONS.

(Replacement manuals are available from your local dealer)
T2555-52141

(12) Part number: T4125-56171



(13) Part number: T4125-56181

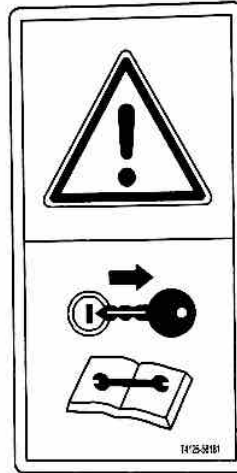

(16) Part number: T4125-56141

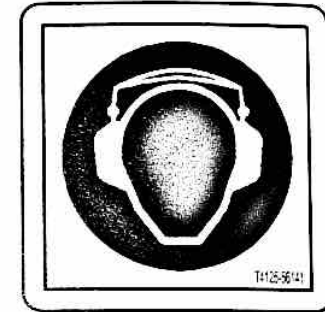

(14) Part number: T4125-56161

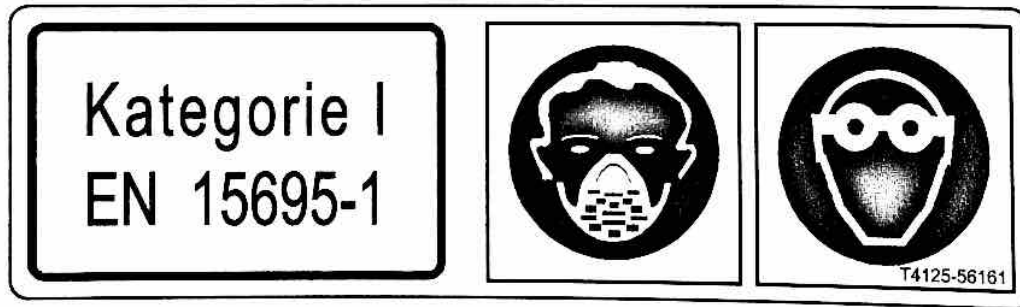

(15) Part number: T4125-56151

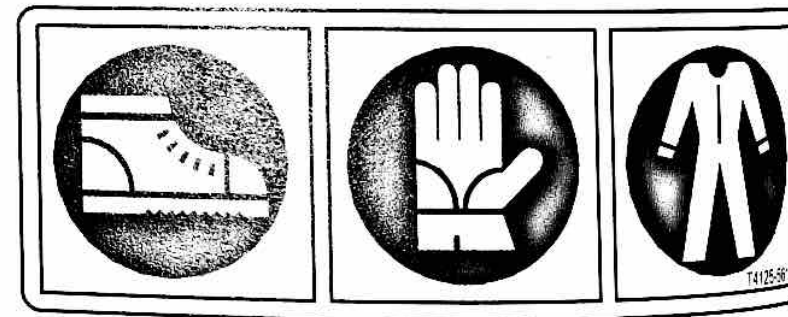

CAUTIONS FOR DECAL MAINTENANCE

Safety decals are attached to the tractor for safe operation. Make sure to follow the instruction on the decals as well as the following instruction:

CAUTION

- **Keep the decals clean and intact. If any decal is dirty, wash it with soap and dry with a soft cloth.**
- **Never use a solvent, such as thinner or acetone, since it can ruin the decals.**
- **Do not spray high-pressure water directly onto the decal. The decal may fall off the tractor.**

IMPORTANT

- **If a decal is damaged or lost, contact your local dealer immediately to install a new decal.**
- **Make sure to attach the decal to the correct position cleanly without bubbles after cleaning its mounting surface.**
- **If a decal is attached to a component to be replaced, replace the decal as well.**

(17) Part number: F6800-29112

This tractor is equipped with a DPF(Diesel Particulate Filter). Use the CJ-4 grade Engine oil. Otherwise, cause DPF failure.



Regeneration Underway Lamp

1. When DPF starts to regenerate, you can see it.
2. When on regeneration, Do not touch the part of DPF because it is very hot.
3. Keep Flammables materials and people away from exhaust pipe.
4. Please keep higher 1700rpm to finish regen fully until underway lamp is off.

1. Park to Safety Area and Clear Around Exhaust Pipe.

2. Operating Condition

- 1) Depress brake pedal and lock it.
- 2) Put gearshift lever in neutral position.
- 3) Hand/Foot Accel. Pedal "Idle Min".
- 4) Warm up the engine for 1~2 minutes.
- 5) Do not depress clutch pedal.
- 6) Press switch over 2 Seconds.

3. When RPM automatically increase and enter manual regen

- 1) If white smoke is visible in cold condition, In 3 minutes RPM increase, engage the load with joystic lever in one direction over 2 minutes
- * Warning : Pay attention to accidents with joystick load.

2) When DPF regen is finished, DPF underway lamp will be go out.

4. Normally, it will take 30~40 minutes.



When you see this warning Lamp

BEFORE OPERATION

VEHICLE IDENTIFICATION NUMBER.....	2-2
PRODUCTION SERIAL NUMBER	2-2
ENGINE SERIAL NUMBER	2-2
TRANSMISSION NUMBER	2-2
ESSENTIAL REPLACEMENT PARTS	2-3
OILS AND FLUIDS	2-3
FILTERS	2-4
BELTS AND RUBBER PARTS	2-4
OTHER COMPONENTS	2-5

VEHICLE IDENTIFICATION NUMBER PRODUCTION SERIAL NUMBER ENGINE SERIAL NUMBER

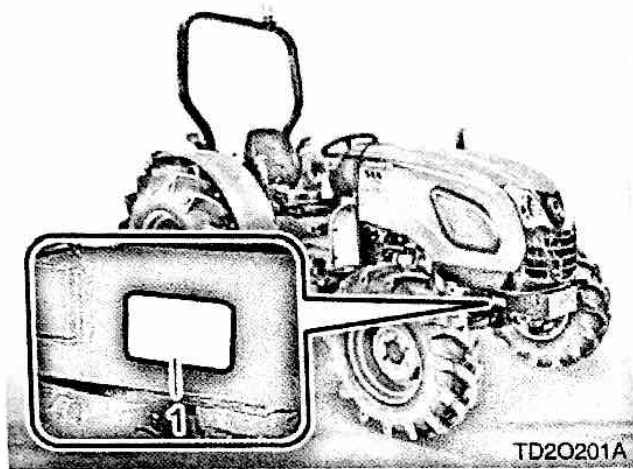

(1) Production serial number

This number is to identify the vehicle, and its plate is attached on the front right side of the front axle frame.

This number is also printed on the bar code label which is located on the dash board cover on your right hand side.

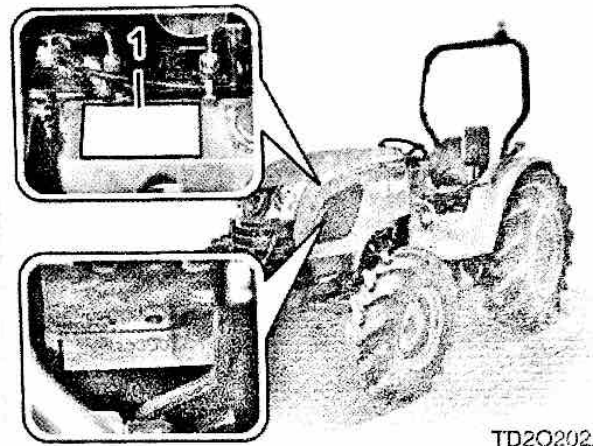

(1) Engine serial number

Engine identification plate is installed on the cylinder head cover. This number indicates the engine type, displacement, injection timing, and date of manufacture.

The engine serial number is also stamped on the cylinder block behind the gear case.

TRANSMISSION NUMBER

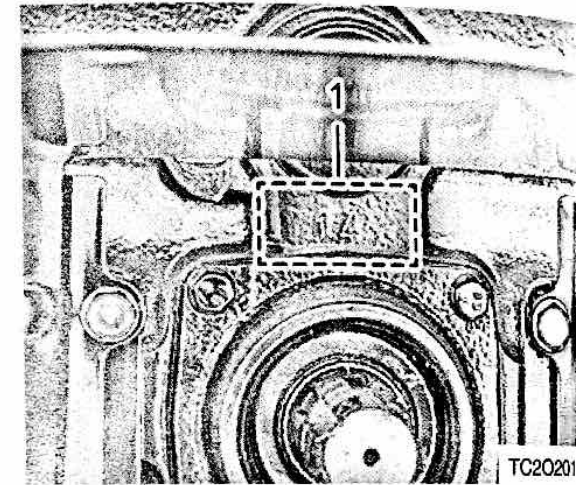

(1) Transmission number

The transmission number is engraved on the rear end of transmission case.

ESSENTIAL REPLACEMENT PARTS OILS AND FLUIDS

When in need of parts, be prepared to give your dealer both the tractor and engine serial numbers.

Fill in the following fields so that the production and engine serial numbers can be provided immediately when service is needed:

• Tractor Serial No:

• Engine Serial No:

• Transmission number

• Date of Purchase

(To be filled in by purchaser)

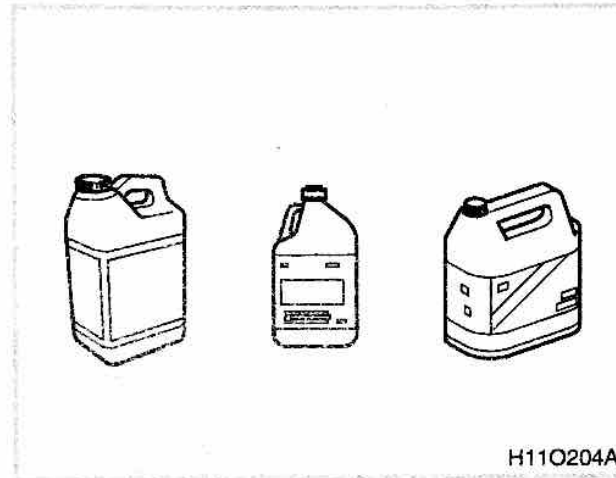

Various oils and fluids are used in this tractor for operation, lubrication, cooling, and anti-corrosion of various parts.

If oil or fluid is insufficient, contaminated or degraded, it can cause poor performance, incorrect operation, and seized parts of the tractor, leading to malfunction.

Regularly add or change the fluid specified on the right to keep the tractor in good condition.

No.	Item	Specification	Capacity [U.S.gal. (L)]
1	Engine oil	Tier2 or 3 (Without DPF) - API CH grade above Tier4 (With DPF) - API CJ grade above SAE 10W30, 10W40, 15W40	1.58 (6.0): US 1.45 (5.5): EU/AU/TH
2	Transmission fluid	DAEDONG : UTF55 or S h e l l : Donax-TD, Exxonmobil: Mobilfluid 424 Exxon Hydraul 560 B P : Tractran UTH	5.81 (22.0)
3	Grease	SAE multi purpose type grease	As needed
4	Coolant	Fresh clean water with ethylene glycol (50:50)	2.72 (10.3): US 2.64 (10.0): EU/AU/TH

FILTERS

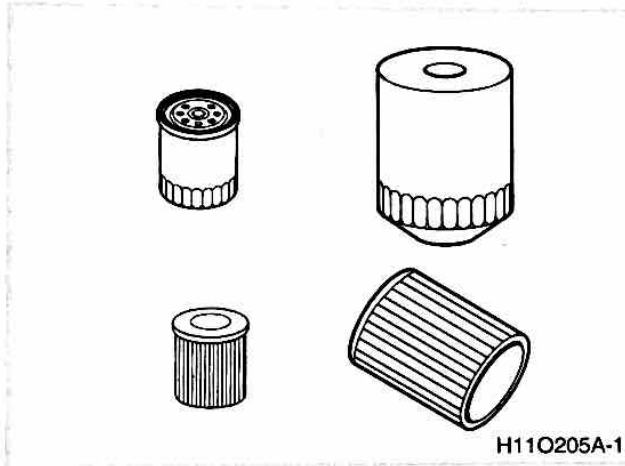

Filters for the engine, transmission, air cleaner, and A/C are consumables that purify oil and air. Make sure to replace these items when changing oil.

No.	P/N	Item	Qty
1	E6201-32443	Engine oil filter	1
2	T5710-38031	Hydraulic filter	1
3	T4624-11012	Air cleaner ass'y	1
4	E7230-11081	Air cleaner element	1
5	T4682-25732	Fuel filter ass'y (B series)	1
6	F5805-16402	Fuel filter ass'y (F series)	1
7	T4682-43172	Fuel filter element (B series)	1
8	F6800-16411	Fuel filter element (F series)	1

BELTS AND RUBBER PARTS

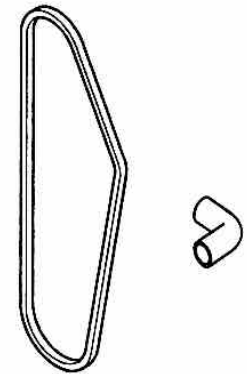

Belts, hoses and boots, which are made of rubber, get weakened and cracked as they age. If these parts are kept left in this state, they can be broken off, leading to a serious problem in the tractor. Therefore, regularly check or replace those items to prevent the failure.

No.	P/N	Item	Qty
1	E6857-72531	Fan belt (B series)	1
2	F6800-72531	Fan belt (F series)	1

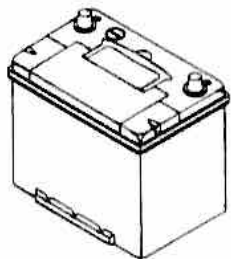
OTHER COMPONENTS

H11O207A

The battery condition is very important for engine start performance especially in winter. Therefore, make sure to check its condition daily to prevent its discharge. Also, check its service life and electrolyte condition regularly.

No.	P/N	Item	Qty
1	C7910-42205	Battery	1

SPECIFICATIONS

SPECIFICATIONS.....	3-2
EXTERNAL DIMENSIONS	3-2
MAJOR SPECIFICATIONS.....	3-4
DRIVING SPEED TABLE.....	3-11
IMPLEMENT LIMITATIONS.....	3-13
STANDARD IMPLEMENT DIMENSIONS.....	3-13

SPECIFICATIONS

EXTERNAL DIMENSIONS

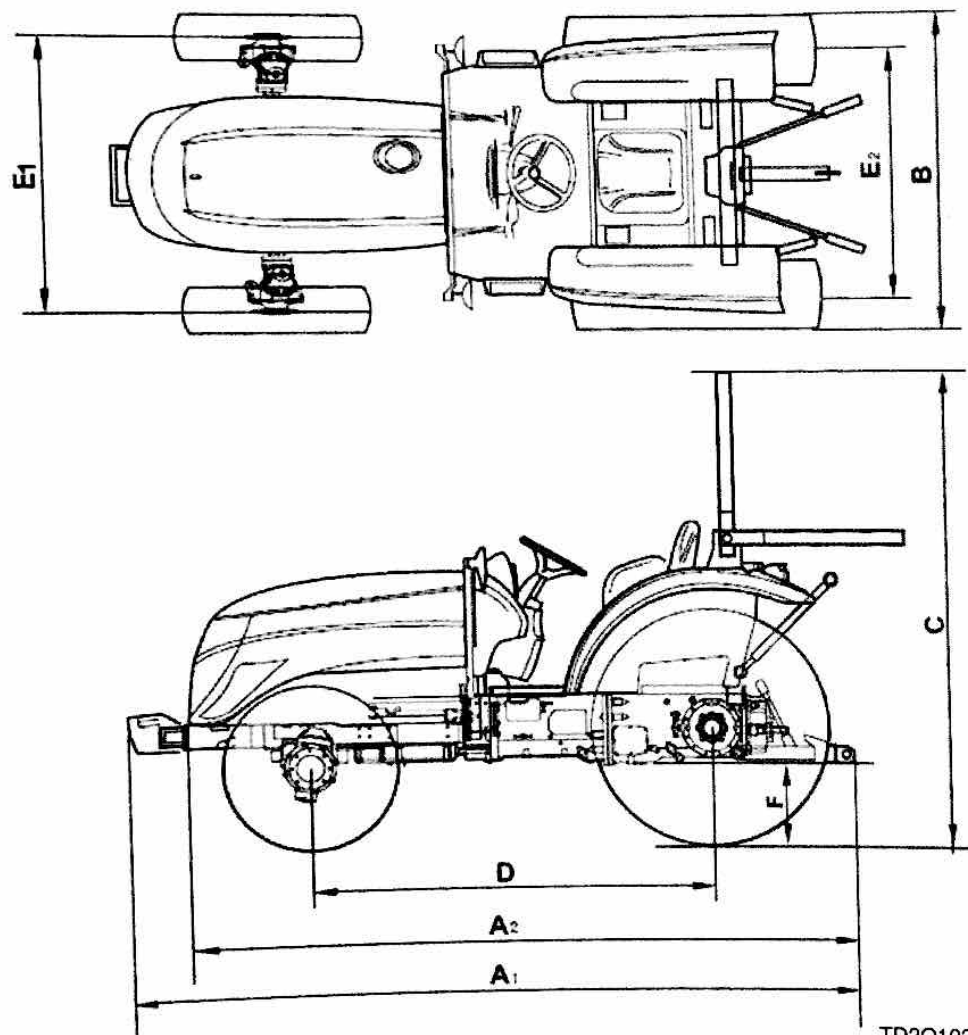

TD20103A

Item	in. (mm)	
	US	EU,TH
1. Overall length (A1)	128.3 (3,260)	
2. Overall length (A2)	120.9 (3,070)	
3. Overall width (B)	55.1 (1,400)	
4. Overall height (C)	99.2 (2,520)	104.3 (2,650)
5. Wheel base (D)	65.7 (1,670)	
6. Tread (E1)	44.6 (1,132)	
7. Tread (E2)	51.3 (1,302)	
8. Ground clearance (F)	13.4 (340)	

- * A1: Overall length including weight
- * A2: Overall length excluding weight
- * E1: Front wheel tread
- * E2: Rear wheel tread

* Note: These dimensions are measured with the standard tires (AG) installed to the ROPS model tractor.

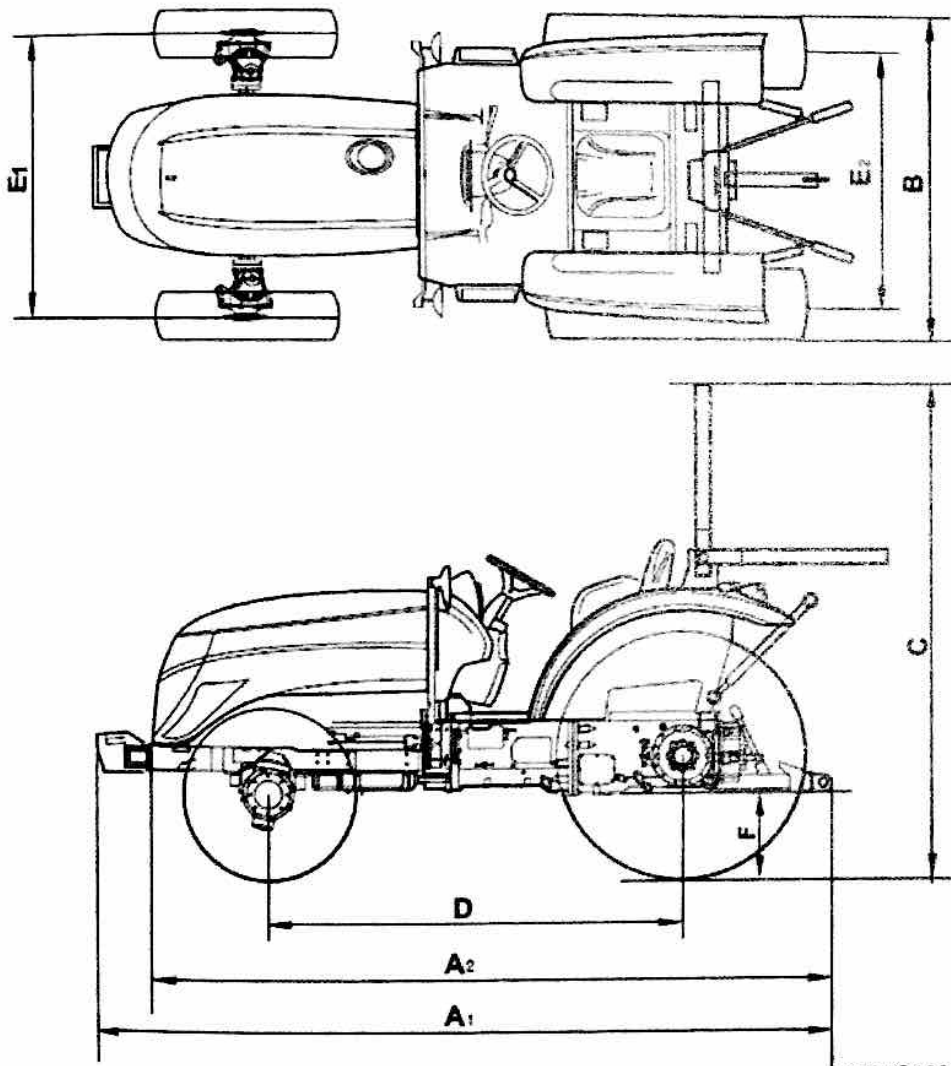

TD2O103A

in. (mm)

Item	CK4010F / CK4010HF
	AU
1. Overall length (A1)	138.6 (3,520)
2. Overall length (A2)	122.2 (3,105)
3. Overall width (B)	62.8 (1,595)
4. Overall height (C)	96.9 (2,460)
5. Wheel base (D)	65.7 (1,670)
6. Tread (E1)	49.1 (1,247)
7. Tread (E2)	47.3 (1,202)
8. Ground clearance (F)	11.9 (300)

- * A1: Overall length including weight
- * A2: Overall length excluding weight
- * E1: Front wheel tread
- * E2: Rear wheel tread

* Note: These dimensions are measured with the standard tires (AG) installed to the ROPS model tractor.

MAJOR SPECIFICATIONS [MANUAL]

Item			Model				
			CK2610	CK3510	CK4010	CK4010F	
Engine	Model	US	3A165LWM-U	3F-TM4-U	←	-	
		EU	-	3B183LWM-E1	3B183LWM-E	-	
		TH	-	3B183LWM-E1	3B183LWM-E	-	
		AU	-	-	-	3B183LWM-E	
	No. of cylinders		3				
	Total displacement		cc	1,647	1,826		
	Bore and stroke		in. (mm)	87 × 92.4 (3.4 × 3.63)		3.4 × 4.03 (87 × 102.4)	
	Engine gross power HP(kW)		US	24.5 (18.2)	34.9 (26)	39.6 (29.5)	-
			EU/TH	-	35 (26.1)	38 (28.3)	-
			AU	-	-	-	38 (28.3)
Rated revolution		rpm	2,400	2,600	←	←	
Capacity	Fuel tank		U.S gal (L)	8.98 (34)	←	←	←
	Transmission fluid		U.S gal (L)	5.81 (22.0)	←	←	←
	Coolant U.S gal (L)		US	2.72 (10.3)	←	←	←
			EU/AU/TH	2.64 (10.0)	←	←	←
	Engine oil U.S gal (L)		US	1.58 (6.0)	←	←	-
			EU/TH	1.45 (5.5)	-	←	←
			AU	-	-	-	1.45 (5.5)
Front axle oil		U.S gal (L)	1.58 (6.0)	←	←	-	
Driving system	Clutch		Dry Dual				
	Transmission		Shuttle shift	N/A			
			Main shift type	Synchromesh/3-gear			

Item			Model				
			CK2610	CK3510	CK4010	CK4010F	
Driving system	Transmission	Range shift type	Constant mesh / 3-gear	←	←	←	
		Speeds	9×3	←	←	←	
	Ground speed (Tire for agricultural) mph(Km/h)	Forward	0.77~10.08 (1.24~16.23)	0.94~14.62 (1.52~23.53)	←	←	
		Reverse	0.96~6.59 (1.55~10.60)	1.90~15.38 (1.18~9.56)	←	←	
	4WD (Front Wheel Drive)		Manual	←	←	←	
	Brake		Wet disc type	←	←	←	
	Differential lock		Rear Standard	←	←	←	
Tires	Agricultural	Front	7-16 / 6PR	←	←	←	
		Rear	11.2-24 / 4PR	←	←	←	
	Turf (TH: N/A)	Front	25 x 8.5-14	←	←	←	
		Rear	13.6-16	←	←	←	
	Industrial (TH: N/A)	Front	US: 27 x 8,5 - 15 EU: 25 x 8,5 - 14	←	←	←	
		Rear	15-19.5	←	←	←	
Hydraulic system	Pump capacity		gpm (L/min.)	11.73 (44.4)	←	←	←
	Steering		Hydrostatic power steering		←	←	←
	Hydraulic lift control		Position control		←	←	←
	3-Point hitch		Category 1		←	←	←
	Max. lifting capacity	lbs.(kg.f)	At lift point	2,270 (1,030)	←	←	←
			At 24 in.behind lift point	1,631 (740)	←	←	←
No. of external hydraulic valves			4 (Rear / Option)	←	←	←	

Item			Model				
			CK2610	CK3510	CK4010	CK4010F	
P T O	Rear	Type	Live				
		PTO shaft	1 - 3/8" 6 splines				
		Speed rpm	1st	540			
			2nd	US/AU: N/A, EU/TH: 750			
Min. turning radius (With one rear wheel braked)		in.(mm)	96.46 (2,450)				
Weight (with ROPS)		lbs.(kg.f)	2,634 (1,195)	US: 2,733 (1,240) / EU,TH: 2,634 (1,195)		2,753 (1,249)	
Max. Drawbar vertical load		lbs.(kg.f)	1,433 (650)				
Max. Trailer loading weight		lbs.(kg.f)	6,613 (3,000)				
Option	Body Color		Orange	←	←	Yellow	
	Sun Canopy		○	←	←	←	
	Front Grille Guard		○	←	←	←	
	SMV Sign		○ (TH: N/A)	←	←	N/A	
	Cup Holder		○ (1EA)	←	←	←	
	Tool Box		○	←	←	←	
	Drawbar		○	←	←	N/A	
	Lower Link (Telescope)		○ (US Only)	←	←	←	
	Lift Rod (GEAR)		○ (US Only)	←	←	←	
	Check Link (Telescope)		○ (US Only)	←	←	←	
	Fuel Heater		○ (US Only)	←	←	←	
	Step Mat		○ (US Only)	←	←	standard	
Safety Filter		○ (US Only)	←	←	←		

※ Note: The specifications are subject to change without notice.

[HST]

Item		Model					
		CK2610H	CK3510H	CK4010H	CK4010HF		
Engine	Model	US	3A165LWH-U	3F-TH4-U	←	-	
		EU	-	3B183LWH-E1	3B183LWH-E	-	
		TH	-	N/A	←	-	
		AU	-	-	-	3B183LWH-E	
	No. of cylinders		1,647	1,826			
	Total displacement		cc	87 × 92.4 (3.4 × 3.63)			
	Bore and stroke		in. (mm)	3.4 × 4.03 (87 × 102.4)			
	Engine gross power HP(kW)		US	24.5(18.2)	34.9(26)	39.6(29.5)	-
			EU/TH	-	35(26.1)	38(28.3)	-
			AU	-	-	-	38(28.3)
Rated revolution		rpm	2,400	2,600	←	←	
Capacity	Fuel tank		U.S gal (L)	8.98 (34)	←	←	←
	Transmission fluid		U.S gal (L)	5.81 (22.0)	←	←	←
	Coolant U.S gal (L)		US	2.72 (10.3)	←	←	←
			EU/AU/TH	2.64 (10.0)	←	←	←
	Engine oil U.S gal (L)		US	1.58 (6.0)	←	←	-
			EU/TH	1.45 (5.5)	-	←	←
			AU	-	-	-	1.45 (5.5)
Front axle oil		U.S gal (L)	1.58 (6.0)	←	←	-	
Driving system	Clutch		Dry single				
	Transmission		Shuttle shift	N/A			
			Main shift type	HST			

Item			Model				
			CK2610H	CK3510H	CK4010H	CK4010HF	
Driving system	Transmission	Range shift type	3 Range	←	←	←	
		Speeds	3	←	←	←	
	Ground speed (Tire for agricultural) mph (Km/h)	Forward	0~10.31 (0~16.60)	0~14.85 (0~23.91)	←	←	
		Reverse	0~9.28 (0~14.94)	0~13.37 (0~21.52)	←	←	
	4WD (Front Wheel Drive)		Manual	←	←	←	
	Brake		Wet disc type	←	←	←	
	Differential lock		Rear Standard	←	←	←	
Tires	Agricultural	Front	7-16 / 6PR	←	←	←	
		Rear	11.2-24 / 4PR	←	←	←	
	Turf (TH: N/A)	Front	25 x 8.5-14	←	←	←	
		Rear	13.6-16	←	←	←	
	Industrial (TH: N/A)	Front	US: 27 x 8.5 - 15 EU: 25 x 8.5 - 14	←	←	←	
		Rear	15-19.5	←	←	←	
Hy- draulic system	Pump capacity		gpm (L/min.)	11.73 (44.4)	←	←	←
	Steering			Hydrostatic power steering	←	←	←
	Hydraulic lift control			Position control	←	←	←
	3-Point hitch			Category 1	←	←	←
	Max. lifting capacity	lbs.(kg.f)	At lift point	2,270 (1,030)	←	←	←
			At 24 in.behind lift point	1,631 (740)	←	←	←
No. of external hydraulic valves				4 (Rear / Option)	←	←	←

Item			Model				
			CK2610H	CK3510H	CK4010H	CK4010HF	
P T O	Rear	Type	Live				
		PTO shaft	1 - 3/8" 6 splines				
		Speed rpm	1st	540			
			2nd	US/AU: N/A, EU/TH: 750			
Min. turning radius (With one rear wheel braked)			in.(mm)	96.46 (2,450)			
Weight (with ROPS)			lbs.(kg f)	2,690 (1,220)	US: 2,733 (1,240) / EU: 2,690 (1,220)		
Max. Drawbar vertical load			lbs.(kg f)	1,433 (650)			
Max. Trailer loading weight			lbs.(kg f)	6,613 (3,000)			
Option	Body Color		Orange	←	←	Yellow	
	Sun Canopy		○	←	←	←	
	Front Grille Guard		○	←	←	←	
	SMV Sign		○ (TH: N/A)	←	←	N/A	
	Cup Holder		○ (1EA)	←	←	←	
	HST Speed Cruise Control		○ (HST Only)	←	←	←	
	HST Linked Pedal		○ (HST Only)	←	←	←	
	Tool Box		○	←	←	←	
	Drawbar		○	←	←	N/A	

Item		Model			
		CK2610H	CK3510H	CK4010H	CK4010HF
Option	Lower Link (Telescope)	○ (US Only)	←	←	←
	Lift Rod (GEAR)	○ (US Only)	←	←	←
	Check Link (Telescope)	○ (US Only)	←	←	←
	Fuel Heater	○ (US Only)	←	←	←
	Step Mat	○ (US Only)	←	←	Standard
	Safety Filter	○ (US Only)	←	←	←

※ Note: The specifications are subject to change without notice.

DRIVING SPEED TABLE

[CK2610 - MANUAL]

mph (Km/h)

Range shift	Main shift	Tire size 11.2-24 (AG)	
		Forward	Reverse
Low speed	1	0.77 (1.24)	0.96 (1.55)
	2	1.00 (1.62)	
	3	1.48 (2.38)	
Medium speed	1	2.09 (3.36)	2.62 (4.21)
	2	2.73 (4.40)	
	3	4.00 (6.44)	
High speed	1	5.27 (8.48)	6.59 (10.60)
	2	6.89 (11.09)	
	3	10.09 (16.23)	

[CK2610H - HST]

mph (Km/h)

Range shift	Main shift	Tire size 11.2-24 (AG)	
		Forward	Reverse
Low speed	1	2.58 (4.15)	2.32 (3.73)
Medium speed	2	6.00 (8.14)	4.55 (7.32)
High speed	3	15.37 (16.60)	9.28 (14.94)

※ These speed values are based on the technical design and can be different from the actual values.

[CK3510 / CK4010 - MANUAL]

Range shift	Main shift	Tire size 11.2-24 (AG)	
		Forward	Reverse
Low speed	1	0.94 (1.52)	1.18 (1.90)
	2	1.23 (1.99)	
	3	1.80 (2.91)	
Medium speed	1	2.99 (4.81)	3.73 (6.00)
	2	3.90 (6.28)	
	3	5.71 (9.20)	
High speed	1	7.64 (12.30)	9.56 (15.38)
	2	9.99 (16.08)	
	3	14.62 (23.53)	

[CK3510 / CK4010 - HST]

Range shift	Main shift	Tire size 11.2-24 (AG)	
		Forward	Reverse
Low speed	1	3.72 (5.98)	3.34 (5.38)
Medium speed	2	7.28 (11.72)	6.56 (10.55)
High speed	3	14.86 (23.91)	13.37 (21.52)

※ These speed values are based on the technical design and can be different from the actual values.

in. (mm)

IMPLEMENT LIMITATIONS

STANDARD IMPLEMENT DIMENSIONS

Implement	Description	CK2610(H) / CK3510(H) / CK4010(H,F,HF)	Remarks
1. Loader	Max. bucket width	66.0 (1,676)	
2. Backhoe with sub frame	Max. digging depth	89.8 (2,280)	Do not use 3 point hitch backhoe
3. Tiller	Max. width	65.2 (1,656)	
4. Box blade	Max. width	84.0 (2,133)	
5. Rear blade	Max. width	84.0 (2,133)	
6. Rotary cutter	Max. width	65.0 (1,650)	
7. Grooming mower	Max. width	72.0 (1,828)	
8. Aerator	Max. width	72.0 (1,828)	
9. Landscape rakes	Max. width	84.0 (2,133)	

FUNCTION DESCRIPTION AND OPERATING TIPS

4

4

EXTERIOR VIEW 4-3

SWITCHES 4-4

MOUNTING LOCATION 4-4

KEY SWITCH 4-5

COMBINATION SWITCH 4-6

HAZARD WARNING FLASHER SWITCH... 4-8

DPF REGENERATION SWITCH 4-8

SPEED CRUISE CONTROL SWITCH
(OPTIONAL) 4-10

INSTRUMENT CLUSTER 4-11

INSTRUMENT CLUSTER FEATURES 4-11

TACHOMETER/HOURMETER 4-12

ECO PTO 4-12

FUEL GAUGE 4-13

ENGINE COOLANT TEMPERATURE
GAUGE 4-13

WATER-IN-FUEL WARNING LAMP 4-14

TURN SIGNAL LAMP 4-14

DPF REGENERATION WARNING LAMP .. 4-15

DPF REGENERATION UNDERWAY LAMP ... 4-15

PTO INDICATOR 4-17

SINGLE BRAKE LIGHT 4-17

ENGINE OIL PRESSURE WARNING LAMP .. 4-18

BATTERY CHARGE WARNING LAMP 4-19

PARKING BRAKE WARNING LAMP 4-19

PREHEAT INDICATOR 4-20

LINKED PEDAL LAMP (OPTIONAL) 4-20

HST CRUISE LAMP (OPTIONAL) 4-20

ERROR INDICATOR 4-21

CONTROLS 4-22

MAIN SHIFT LEVER 4-24

RANGE SHIFT LEVER 4-24

CLUTCH PEDAL 4-25

BRAKE PEDAL 4-25

PARKING BRAKE 4-26

ACCELERATOR PEDAL 4-27

HAND THROTTLE LEVER 4-27

DIFFERENTIAL LOCK PEDAL 4-28

SEAT ADJUSTMENT 4-29

POSITION CONTROL LEVER 4-30

FUNCTION DESCRIPTION AND OPERATING TIPS

LIFTING ARM (LOWER LINK) SPEED	
CONTROL KNOB.....	4-30
PTO SHIFT LEVER	4-31
DOUBLE ACTING LEVER (OPTIONAL)	4-31
LINKED PEDAL LEVER (OPTIONAL).....	4-32
7-PIN SOCKET (OPTIONAL)	4-32
TIRES	4-33
INFLATION PRESSURE	4-35
TREAD.....	4-36
WHEEL TORQUE AND DIRECTION.....	4-38
ADDITIONAL WEIGHT (OPTION).....	4-39

EXTERIOR VIEW

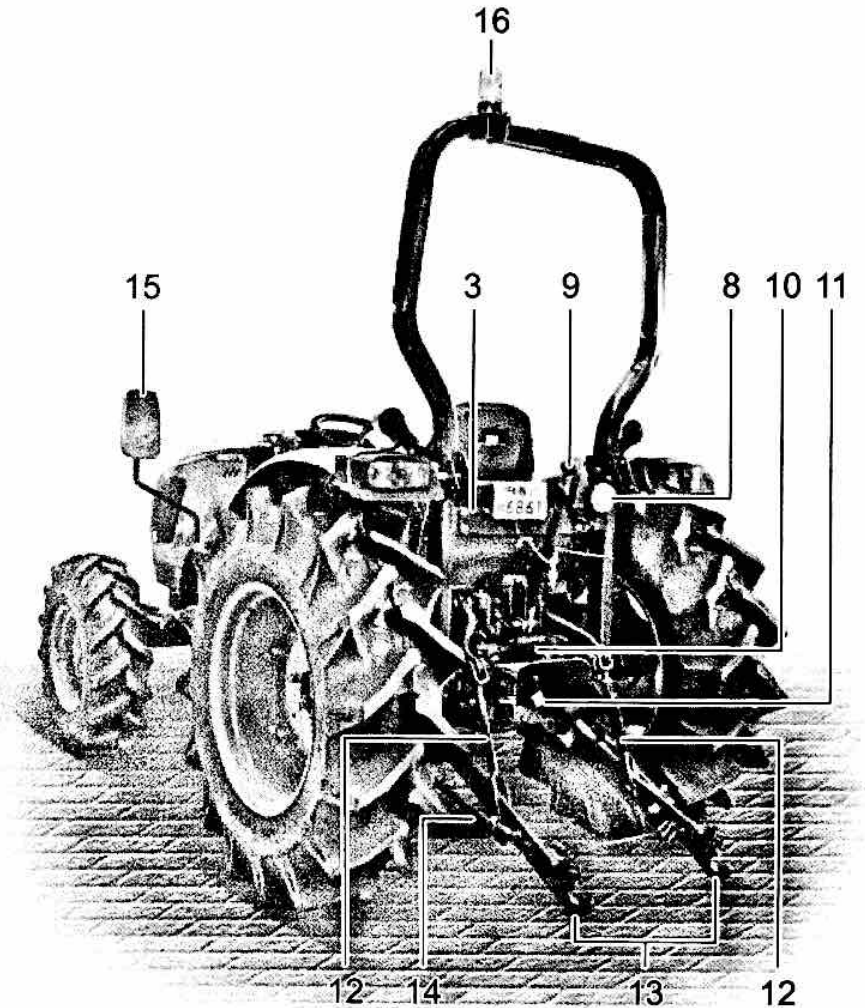
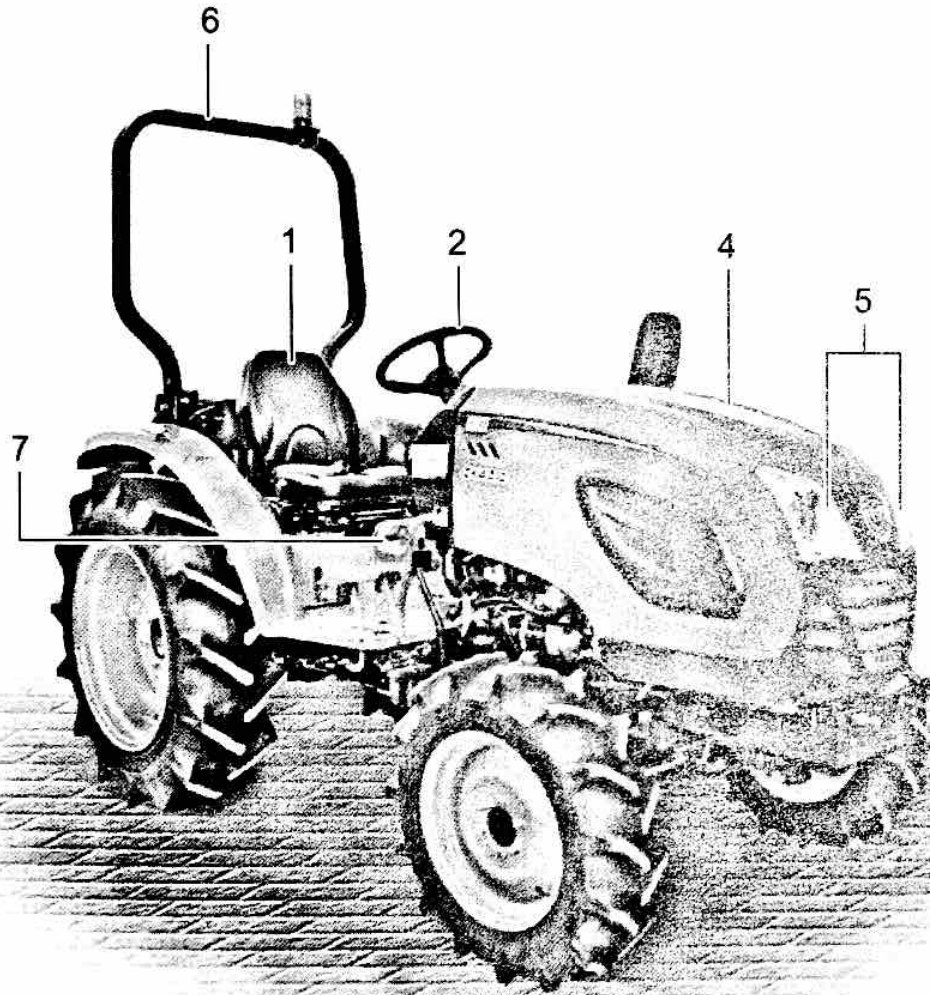

- (1) Seat
- (2) Steering wheel
- (3) Fuel filler port
- (4) Bonnet

- (5) Headlamp
- (6) ROPS
- (7) Turn signal lamp
- (8) Rear work lamp

- (9) Top link
- (10) Oil dipstick
- (11) PTO Shaft
- (12) Lift rod

- (13) Lower link
- (14) Check link
- (15) Rear view mirror
- (16) Beacon lamp

TC2O401B

SWITCHES MOUNTING LOCATION

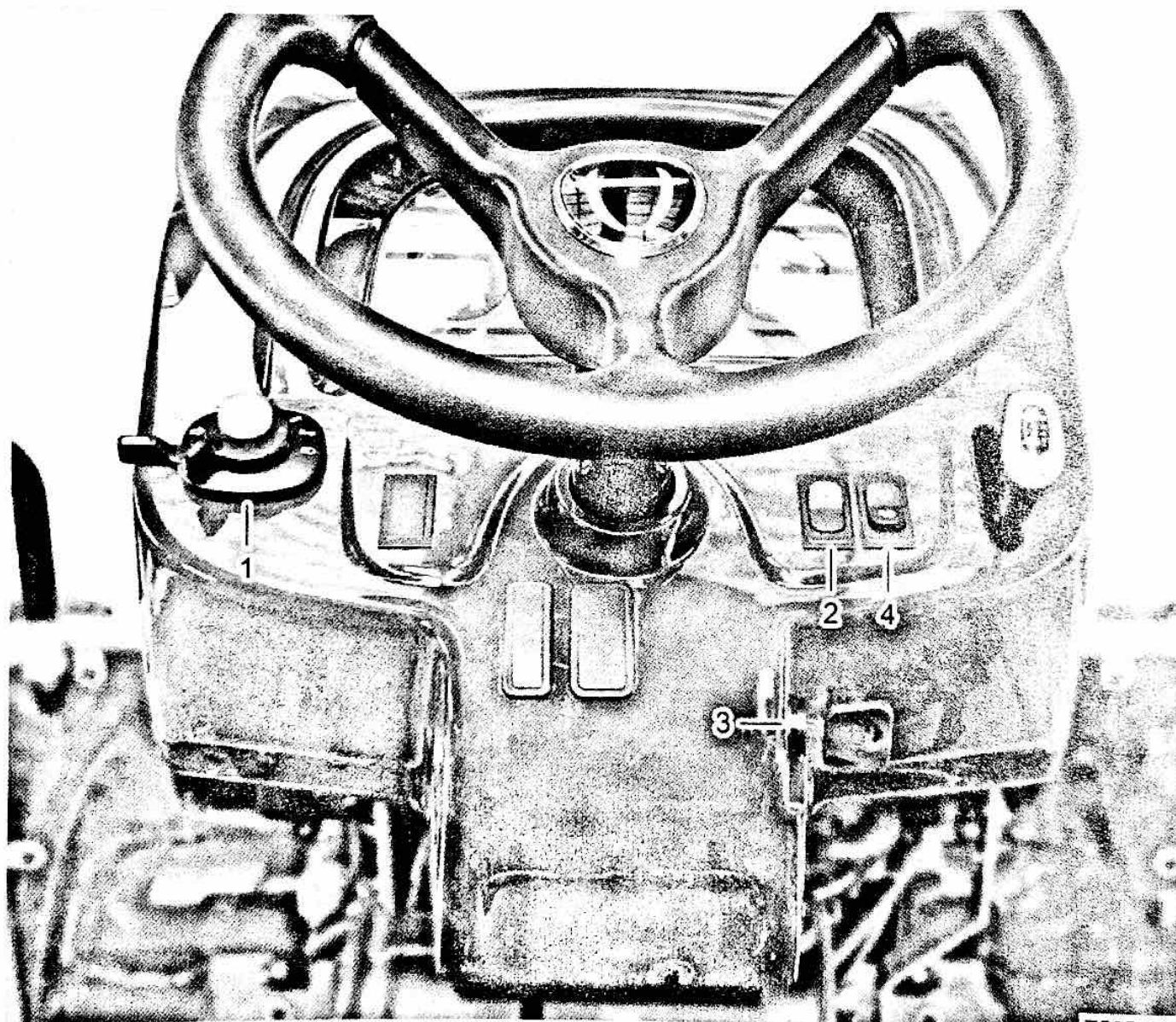

- (1) Combination switch
- (2) Hazard warning flasher switch
- (3) Key switch
- (4) DPF regeneration switch

KEY SWITCH

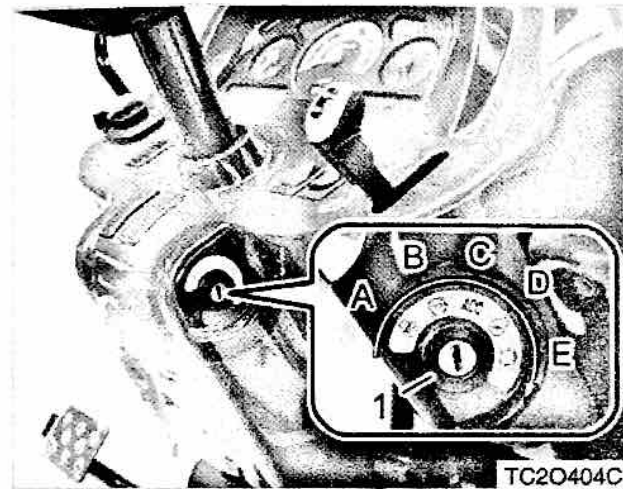

(1) Key switch

(A) Preheat (B) OFF

(C) ACC (D) ON (E) START

• Preheat (A)

The position "A" indicates the "manual preheat." This position is a self-return type, so the key should be held there while preheating. The preheating function can be manually activated if the automatic pre-heating operation is not enough to start the engine. Pre-heating more than 30 seconds consecutively can reduce the preheat system's life.

• OFF (B)

When the key switch is in the position "B," the engine and all electrical devices in the vehicle are turned off. However, flasher lights and turn signal lights can be operated along with their indication lamps on the dashboard.

• ACC (C)

When the key switch is turned to the position "C," the flasher lights and turn signal lights can be operated.

• ON (D)

The position "D" indicates the "ON" position. As soon as the key switch is turned to this position, the oil pressure warning lamp and battery charge warning lamp come on (these turn off after the engine is started) and the automatic preheating function is activated.

The automatic preheating operation is informed by illumination of the preheat indicator on the instrument cluster. In cold weather, preheat the engine sufficiently until the preheat indicator goes off (approx. 9 seconds).

• START (E)

The position "E" indicates "Start." In order to start the engine, depress the clutch pedal and turn the PTO switch off. As soon as the engine is started, release the key then the key will return to the position "D."

⚠ CAUTION

- Stop the engine immediately if the oil pressure warning lamp does not go off after the engine is started. The engine may be severely damaged.
- If the battery charge warning lamp does not go off after the engine is started, check the electrical systems, such as the alternator, for damage. Continuing to use the engine under this condition can discharge the battery or damage other electrical devices.

📖 NOTE

- The ignition key is not directional and can be inserted in any direction. Also, be careful not to leave the tractor unattended with the key in the tractor.
- The horn, turn signal lamp and hazard lamp can be operated without the key inserted.

COMBINATION SWITCH

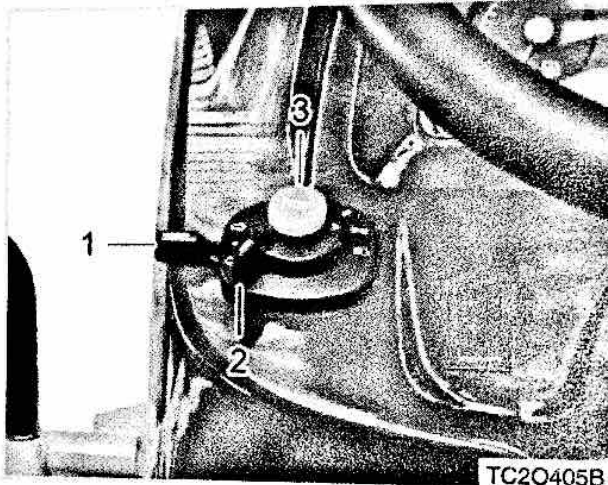

- (1) Turn signal lamp switch
 (2) Headlamp switch
 (3) Horn switch

The combination switch consists of the headlamp, turn signal lamp and horn switches. Its function by its position is as follows:

Switches	Functions
OFF	Head light and tail light OFF
	Low beam and tail light ON
	High beam and tail light ON
	Turn signal lamp ON
	Head light OFF and tail light ON

HEADLAMP SWITCH

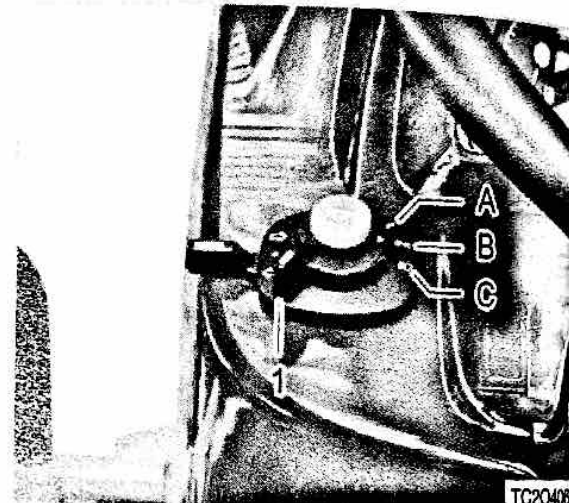

- (1) Headlamp switch
 (A) OFF (B) Low beam ON
 (C) High beam ON

The headlamp switch can be operated only while the key switch is in "ON" position. Turning the headlamp switch clockwise one click will illuminate the low beam headlamps while turning it one more click will illuminate the high beam headlamps.

⚠ WARNING

- *Driving with high beam headlamp ON disturbs the approaching vehicle's visibility for safe driving. Use the high beam headlamps only if necessary.*

TURN SIGNAL LIGHT SWITCH

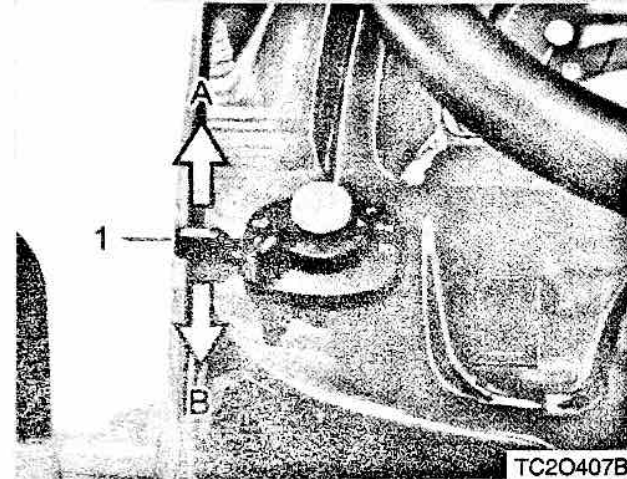

- (1) Turn signal light switch
 (A) Right turn (B) Left turn

The turn signal lights are used when turning the vehicle left or right. Pulling the lever up blinks the right turn signal light while pushing the lever down blinks the left turn signal light.

📖 NOTE

- The turn signal light lever is not a self-return type. Therefore, make sure to return the lever manually after turning the vehicle.
- The turn signal lights can be operated without the key inserted.

HORN SWITCH

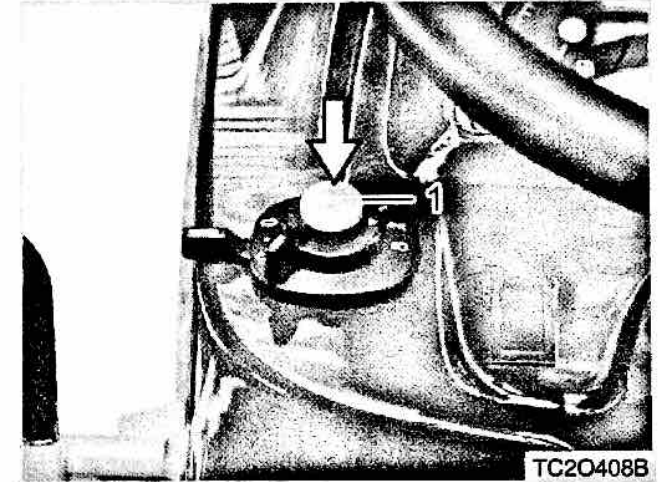

- (1) Horn switch

The horn switch can be operated without the key inserted. Pressing this switch sounds the horn.

HAZARD WARNING FLASHER SWITCH

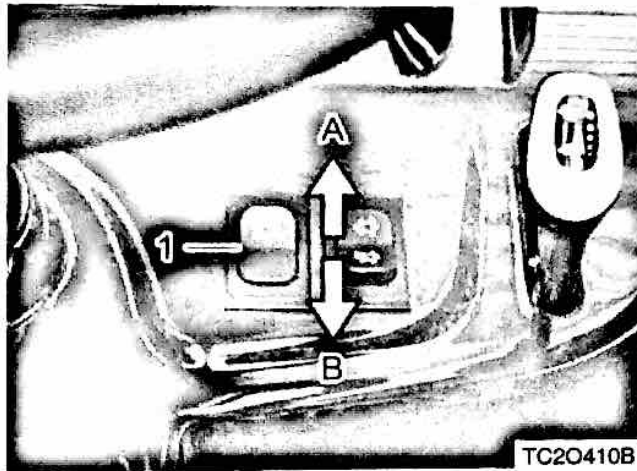

(1) Hazard warning flasher switch
(A) ON (B) OFF

This switch can be used to warn other vehicles when malfunction occurs in the tractor while driving on a public road. Pressing this switch up blinks the hazard lamp and returning it turns off the lamp. The turn signal lights cannot be operated while this switch is pressed up to operate the hazard lamps.

⚠ CAUTION

- If the hazard lamp is turned on for an extended period of time while the engine is stopped, the battery can be discharged. Therefore, use them only in emergency.
- The hazard lamp can be operated without the key inserted.

DPF REGENERATION SWITCH

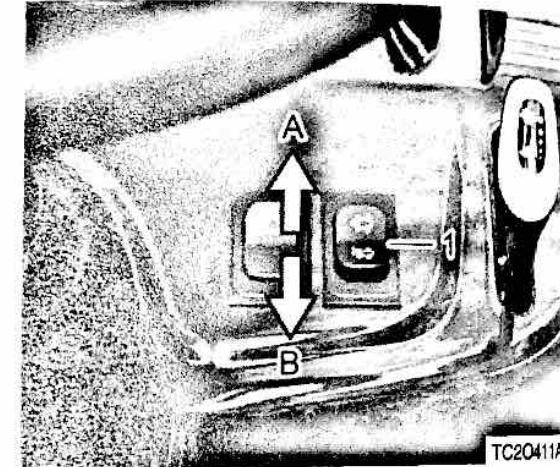

(1) DPF regeneration switch
(A) Activation (B) Deactivation

ACTIVATION (UPPER PORTION OF SWITCH)

Perform the following instructions when the regeneration warning lamp comes on: (see page 4-15.)

1. Park the tractor on a flat surface.
2. Idle the engine.
3. Depress the brake pedals and stop the vehicle.
4. Put all shift levers into the neutral position.

5. Run the engine for 3 to 4 minutes. Then, press the activation portion of the regeneration switch for approx. 2 seconds.

**NOTE**

- The illumination timing of the regeneration process lamp may differ depending on the DPF temperature.

6. The regeneration warning lamp goes off and the regeneration process lamp blinks.

Before resuming your work, wait for approx. 30 to 40 minutes until the regeneration process is completed.

DEACTIVATION (LOWER PORTION OF SWITCH)

Do not press the deactivation portion of the switch while the regeneration process is activated.

However, the switch can be set to the deactivation position to stop the regeneration process in emergency.

**CAUTION**

To protect the catalyst filter, keep the followings:

- Make sure to use only genuine fuel.
- Keep the engine oil change schedule.
- Check the engine oil level frequently to keep it to the specified level.
- Avoid any unnecessary engine idling.
- Never stop the engine during driving.
- Never place the shift lever in the neutral position when driving downhill.
- Do not use any engine oil additive or fuel additive.
- Avoid driving with any warning lamp illuminated.
- Do not allow any flammable materials, such as dry grass and paper, to come near the catalyst filter while parked.

**CAUTION**

To avoid injury:

- Never clean the tractor body while the engine is running.

SPEED CRUISE CONTROL SWITCH (OPTIONAL)

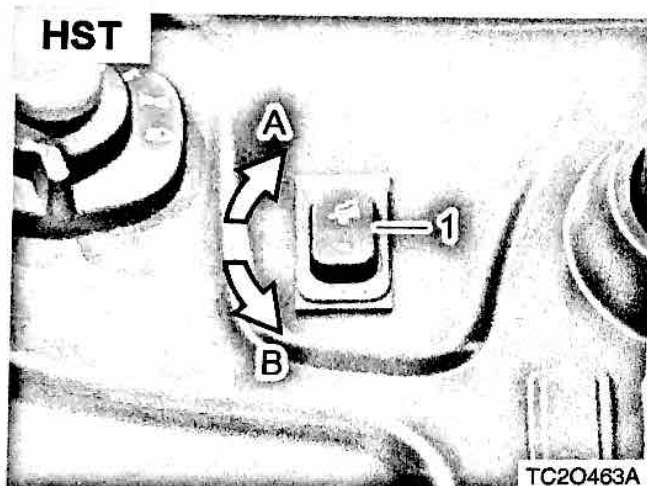

(1) Speed Cruise Control Switch
(A) ON (B) OFF

To activate the cruise control function, set the desired speed and press the switch to the "ON" position.

Depress the HST pedal to increase the driving speed in order to accelerate at a constant speed. To deactivate the cruise function, depress the brake pedal or press the switch to the "OFF" position.

The cruise function is not activated during reverse.

⚠ WARNING

- *Never use the cruise control function on a public or bumpy road or during turning.*
- *Apply the left and right brake pedals before activating the cruise control function.*

INSTRUMENT CLUSTER

INSTRUMENT CLUSTER FEATURES

Symbols on the instrument panel come on when the key switch is turned to the "ON" position.

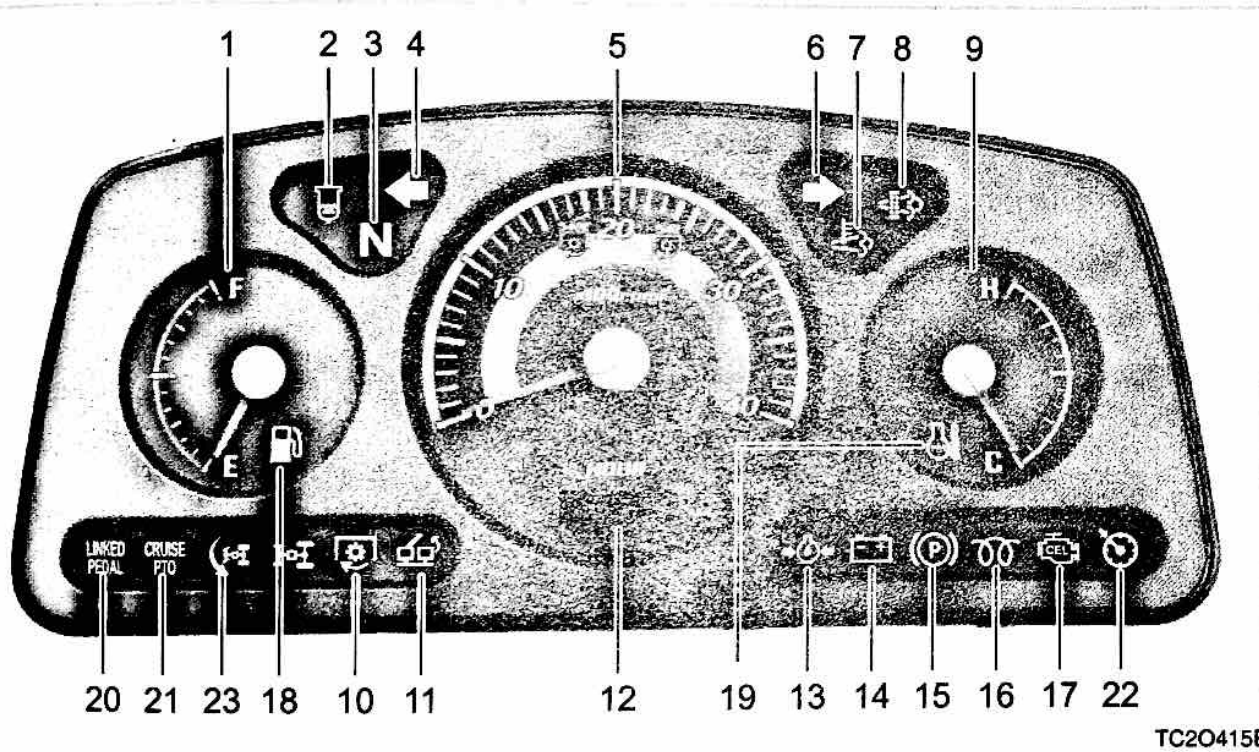

- (1) Fuel gauge
- (2) Water-In-Fuel warning lamp
- (3) Neutral indicator
- (4) Turn signal lamp (LH)
- (5) Tachometer
- (6) Turn signal lamp (RH)
- (7) DPF regeneration underway lamp
- (8) DPF regeneration warning lamp
- (9) Coolant temperature gauge
- (10) PTO Indicator
- (11) Single brake light
- (12) Hourmeter
- (13) Engine oil pressure warning lamp
- (14) Battery charge warning lamp
- (15) Parking brake warning lamp
- (16) Preheat indicator
- (17) Engine check lamp
- (18) Fuel level warning lamp
- (19) Coolant temperature warning lamp
- (20) Linked pedal lamp (Optional)
- (21) Cruise PTO lamp
- (22) HST cruise lamp (Optional)
- (23) Quick turn lamp

TC2O415E

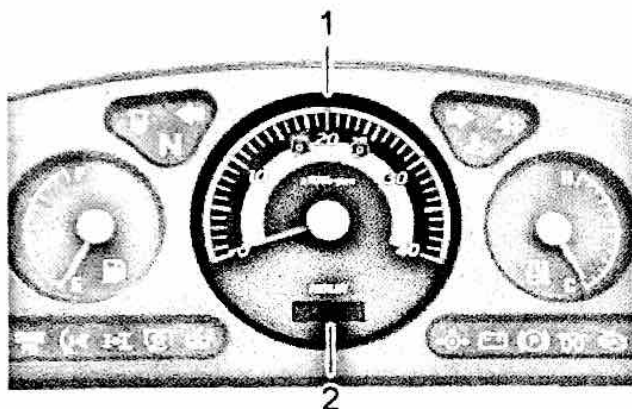
TACHOMETER/HOURMETER

TC2O416C

(1) Tachometer

(2) Hourmeter

The tachometer indicates the engine rpm.

The hour meter indicates the total run hours of the tractor in 6 digits. The last digit represents 1 hour.

The hourmeter does not operate if the engine is stopped even if the key switch is in the "ON" position.

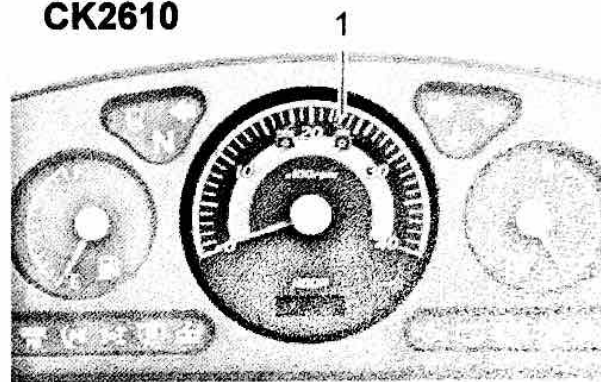
ECO PTO**CK2610**

TC2O416A

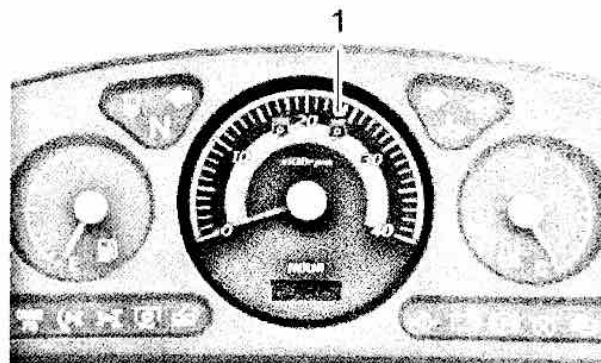
CK3510 / CK4010

TC2O417D

(1) 540 rpm

The PTO speed can be selected as desired according to the operating condition.

The PTO speed ($\frac{540}{5}$) corresponds to the engine speed for the mid range load to achieve 540 PTO RPM with the PTO shift lever in the 1st speed position (540 RPM).

Set the engine speed around this mark for efficient and rapid work.

FUEL GAUGE

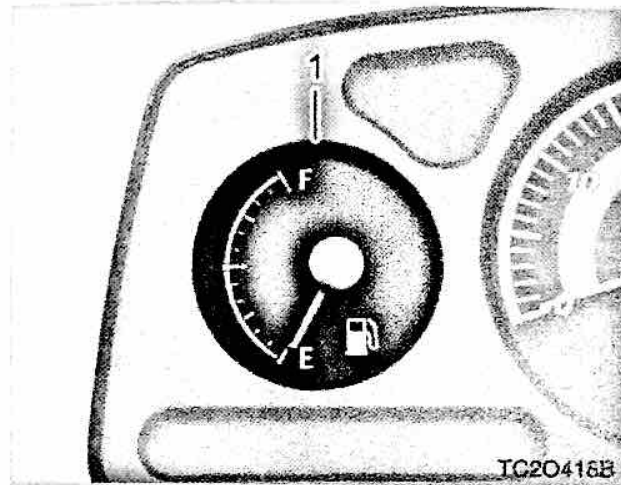

(1) Fuel gauge
E: Empty F: Full

This gauge indicates the remaining fuel level after the key switch is turned to the "ON" position.

- F: Fuel is fully filled.
- E: Replenish the fuel tank.

If driving is continued with the needle below the position "E," air may enter the fuel supply system. In this case, "bleed" the system. (For detailed instructions, refer to "Bleeding fuel system" in the chapter "Maintenance")

⚠ WARNING

- Add fuel immediately when the fuel level warning lamp on the instrument cluster comes on.

📖 NOTE

- Make sure to use only genuine fuel as the engine can be damaged if unqualified fuel is used.
- Use fuel for winter season in cold weather to start the engine easier.
- The gauge needle can move on a hill as fuel slopes in the tank.

ENGINE COOLANT TEMPERATURE GAUGE

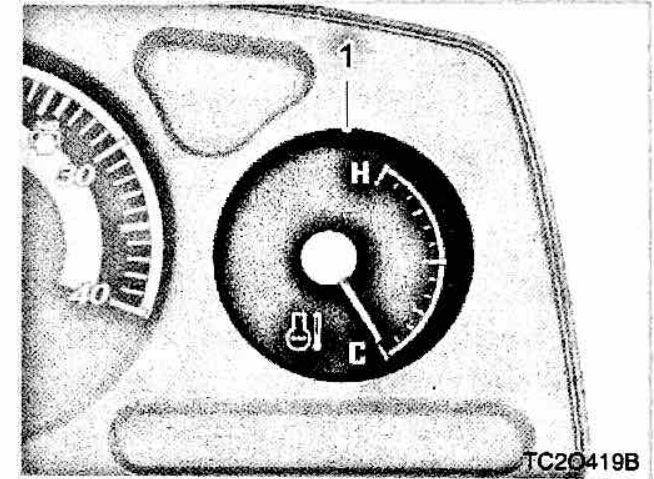

(1) Coolant temperature gauge
(2) Normal operating range
C: Cold H: Hot

This gauge indicates the coolant temperature after the key switch is turned to the "ON" position.

- C: Coolant is cold.
- H: Coolant is hot.

The range marked in "2" in the figure indicates the normal engine temperature. (Normal driving range)

! CAUTION

- Make sure to control the work load so that the needle is not in the red zone.
- If the needle stays in the red zone, do not stop the engine immediately. Instead, reduce the work load to cool down the engine before stopping the engine.
- Make sure to keep the front grill clean so that air is sucked through it freely for fast cooling.

WATER-IN-FUEL WARNING LAMP TURN SIGNAL LAMP

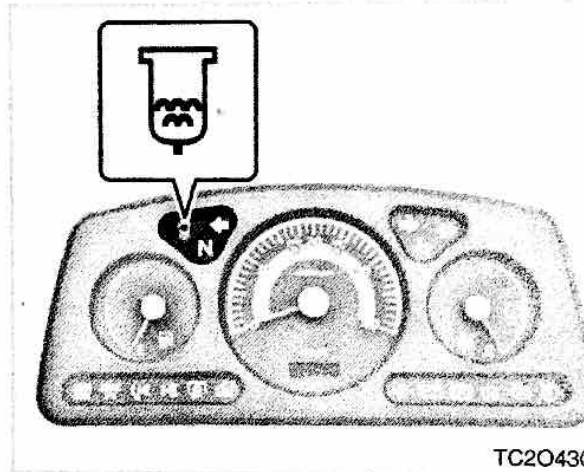

When a certain amount of water (approx. 45 cc) is accumulated in the fuel filter, the warning buzzer sounds. In this case, stop the engine immediately and drain water from the fuel filter.

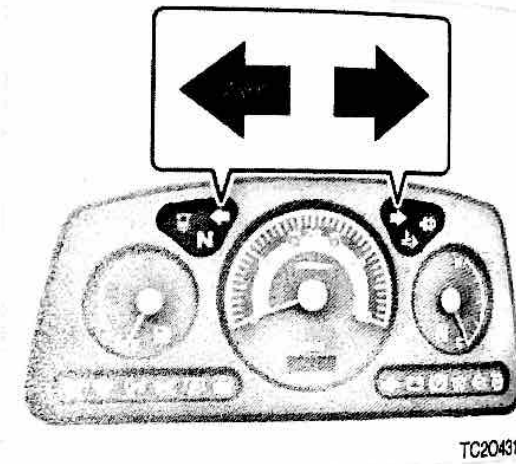

Operating the turn signal lamp switch left and right turns on the corresponding lamp in green.

DPF REGENERATION WARNING LAMP

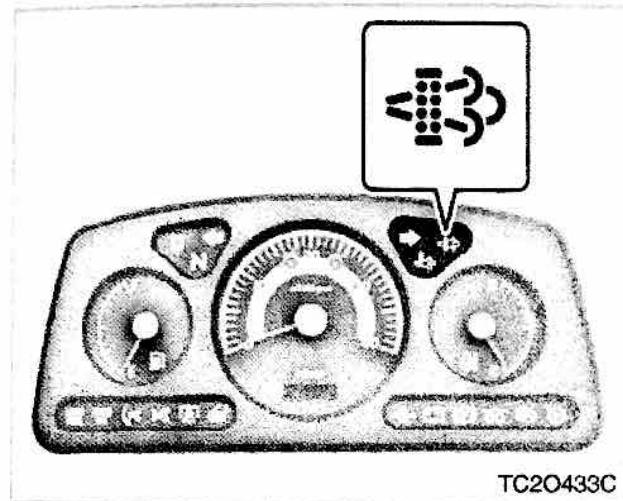

If carbon is accumulated in the exhaust DPF, this warning lamp comes on or blinks.

If this warning lamp comes on, press the "regeneration" button.

DPF REGENERATION UNDERWAY LAMP

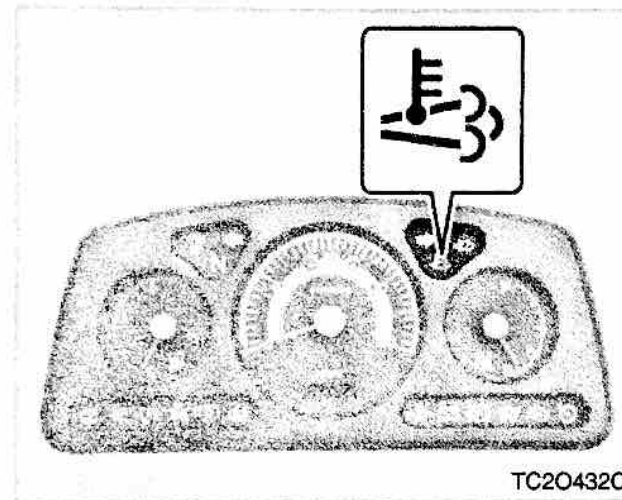

This lamp comes on while the regeneration process is being performed in the DPF.

⊕ IMPORTANT

- If the DPF regeneration underway lamp is illuminated during operation, please keep the engine rpm at 1,500 or above.

⚠ WARNING

- Do not touch or come near the DPF part during the regeneration process as its surrounding area is hot. If not, you can get burnt.

DPF REGENERATION WARNING LAMP

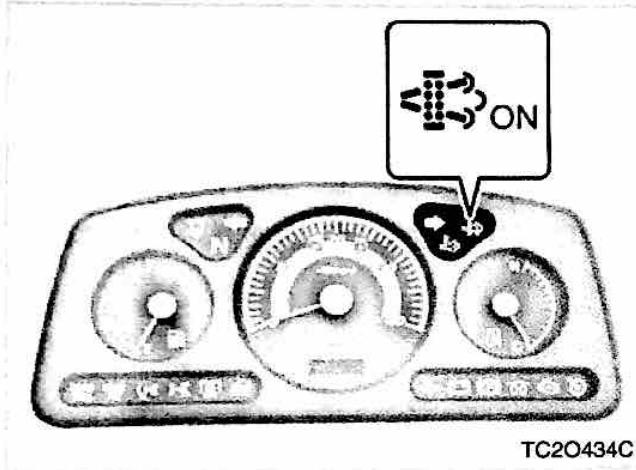

1. Stage 1 warning lamp for DPF clogging
 - : DPF Soot Loading Level 120% - 160%
 - Manual regeneration required
 - Engine RPM limit (below 2,200 rpm)

If this warning lamp comes on, make sure to press the "regeneration" button. (see page 4-8)

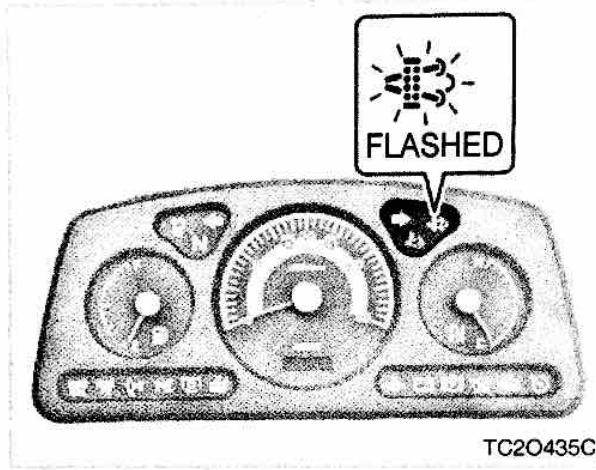

2. Stage 2 warning lamp for DPF clogging
 - : DPF Soot Loading Level 160% - 200%
 - Manual regeneration required
 - Engine RPM limit (below 2,200 rpm)

If the DPF is not regenerated in the stage 1 warning state, the warning lamp blinks. In this state, make sure to perform DPF regeneration process. (see page 4-8)

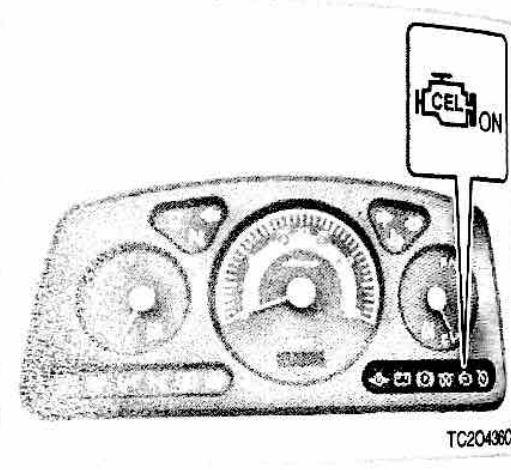

3. Stage 3 warning lamp for DPF clogging
 - : DPF Soot Loading Level 200% or higher
 - Passive regeneration prohibited
 - Engine RPM limit (below 1,500 rpm)

If the DPF is still not regenerated even in this state, the Check engine lamp comes on and the DPF needs to be replaced.

⚠ WARNING

- *In the warning level 3 (CEL lamp ON), both manual and automatic regeneration processes cannot be performed.*
- *When the DPF warning lamp comes on, make sure to perform the manual regeneration as the active regeneration cannot be performed.*
- *Enabling condition for manual regeneration*
 - *Clutch engaged*
 - *Brake ON*
 - *Engine rpm Idle state*
- *If any of the above conditions is not met during regeneration, the regeneration mode is deactivated.*
- *Other general operation cannot be performed during the manual regeneration process. During regeneration, the engine speed is maintained*
 - *at 1,500 rpm for 10 minutes*
 - *at 2,600 rpm for 25 minutes*
 - *at 1,600 rpm for 3 minutes*

PTO INDICATOR

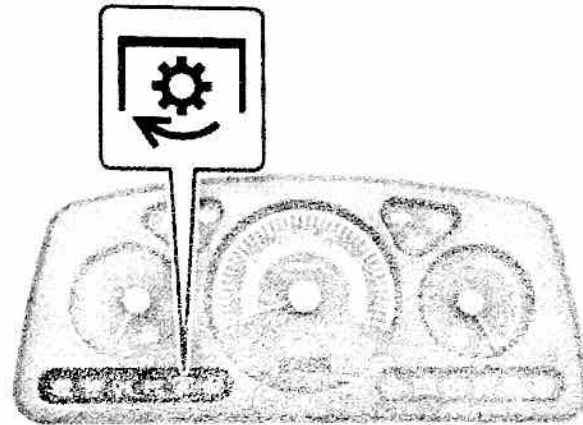

TC2O437C

This indicator shows the PTO engagement condition. When the PTO is engaged, this indicator comes on. When the PTO clutch is disengaged, this indicator goes off.

⚠ CAUTION

- **Set the PTO switch to the "OFF" position in order to start the engine.**

SINGLE BRAKE LIGHT

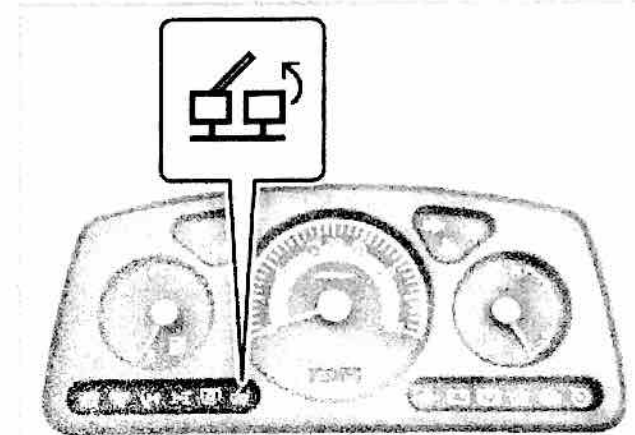

TC2O438C

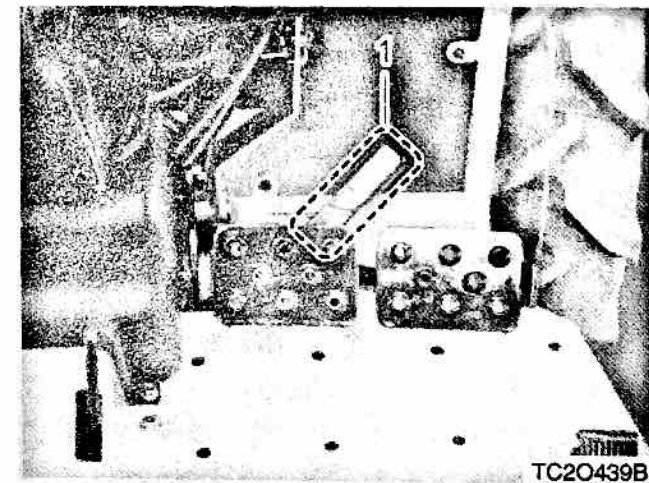

TC2O439B

(1) Brake Pedal Interlock

This lamp indicates the single brake condition. This comes on when the brake pedal interlock is released.

ENGINE OIL PRESSURE WARNING LAMP

⊕ IMPORTANT

- If driving with the brake pedal interlock released (using single brake) on a road or at a high speed, it can lead to a rollover. Follow the instruction.
- If the single brake light is illuminated on the instrument cluster, the brake pedals are disconnected so either brake pedal can be used.
- In a normal operating condition, keep the interlock to the Lock position.

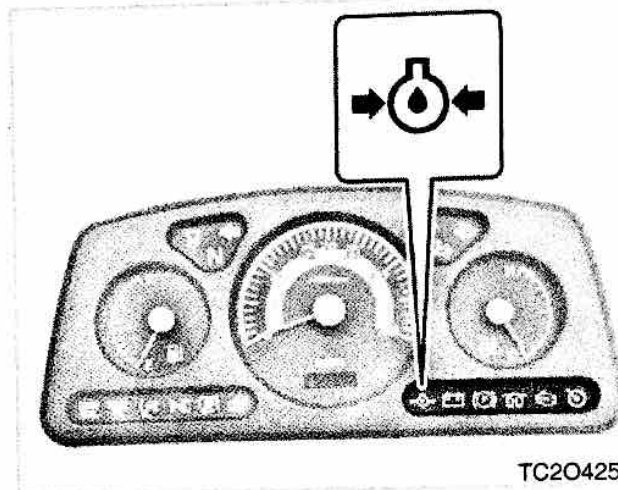

TC2O425C

⚠ CAUTION

- If the oil level is below the specified range, the engine can stall.
- The engine can be severely damaged if driving or operating the tractor with the engine oil warning lamp ON.

This lamp comes on when the engine oil pressure or oil level is low.

This lamp is turned on when the key switch is turned ON before starting the engine but turned OFF after starting the engine. If this lamp comes on while driving, stop the engine immediately and check the engine oil level.

If this lamp comes on even with the specified engine oil level, have the tractor checked by your local dealer or workshop immediately.

BATTERY CHARGE WARNING LAMP

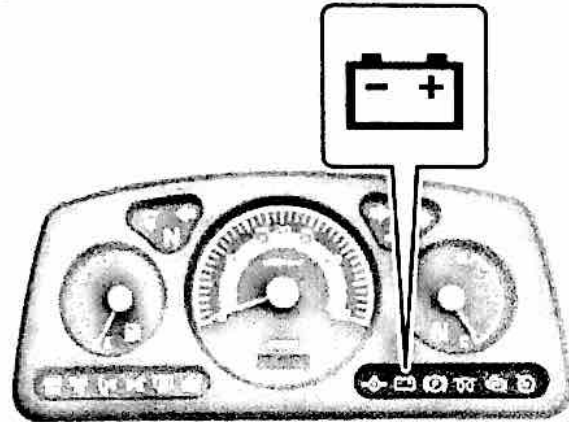

TC20426C

⚠ CAUTION

- If this warning lamp comes on while driving, the charging system, such as the alternator, is malfunctioning. Therefore, turn off all electrical devices and have the tractor checked by your local dealer or workshop as soon as possible.

PARKING BRAKE WARNING LAMP

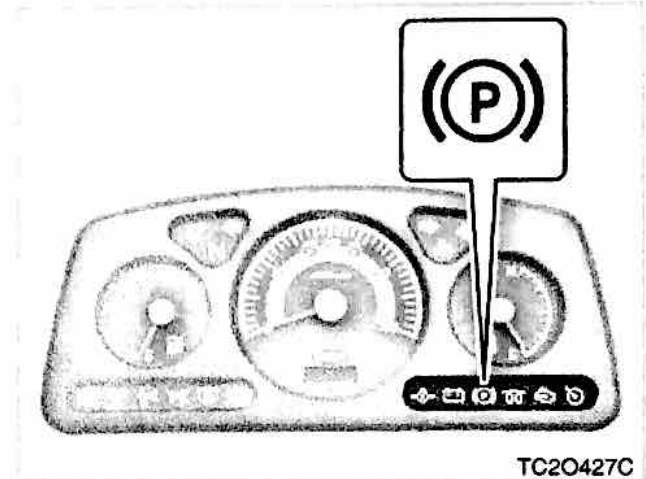

TC20427C

⚠ CAUTION

- If this indicator is ON even with the parking brake released, have the tractor checked by your local dealer or workshop immediately.

This lamp is turned on when the key switch is turned to the ON position before starting the engine, but it is turned off as soon as the engine is started.

When the parking brake is applied, the lamp comes on.

PREHEAT INDICATOR

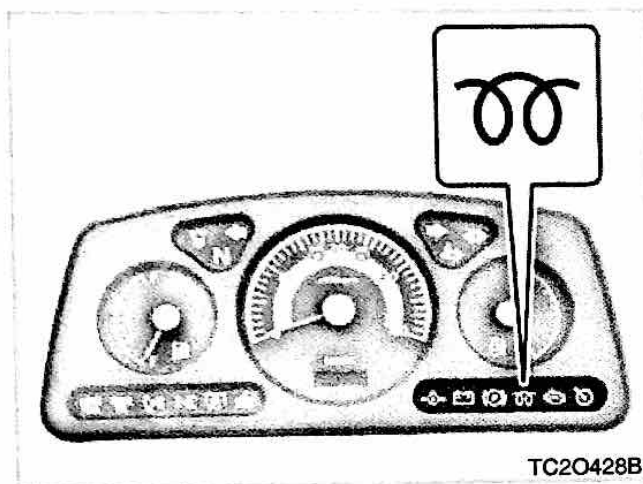

This indicates the operating condition of the preheat system. This indicator comes on for approx. 8 seconds when the key switch is turned to the "ON" position. In case of the basic model, this indicator comes on when the key is held in the "PRE-HEAT" position by an operator.

LINKED PEDAL LAMP (OPTIONAL)

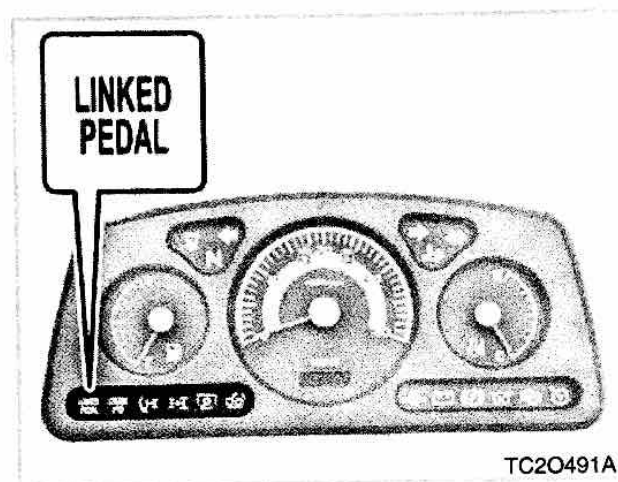

The lamp comes on when the synchronization switch or lever is connected.

HST CRUISE LAMP (OPTIONAL)

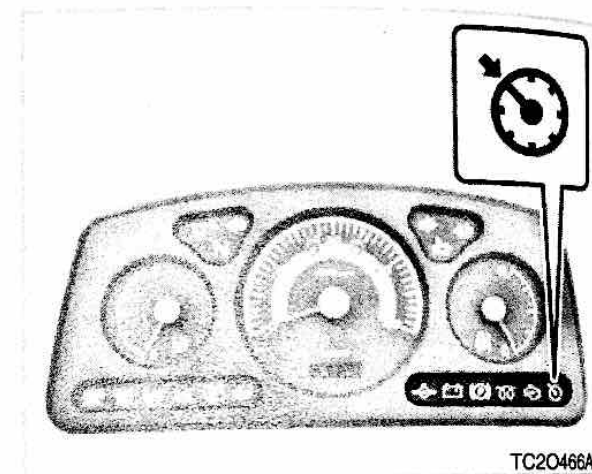

To activate the cruise control function, set the desired speed and press the switch to the "ON" position.

In this case, the speed limit lamp in the cluster meter.

Depress the HST pedal to increase the driving speed in order to accelerate at a constant speed. To deactivate the cruise function, depress the brake pedal or press the switch to the "OFF" position.

The cruise function is not activated during reverse.

ERROR INDICATOR

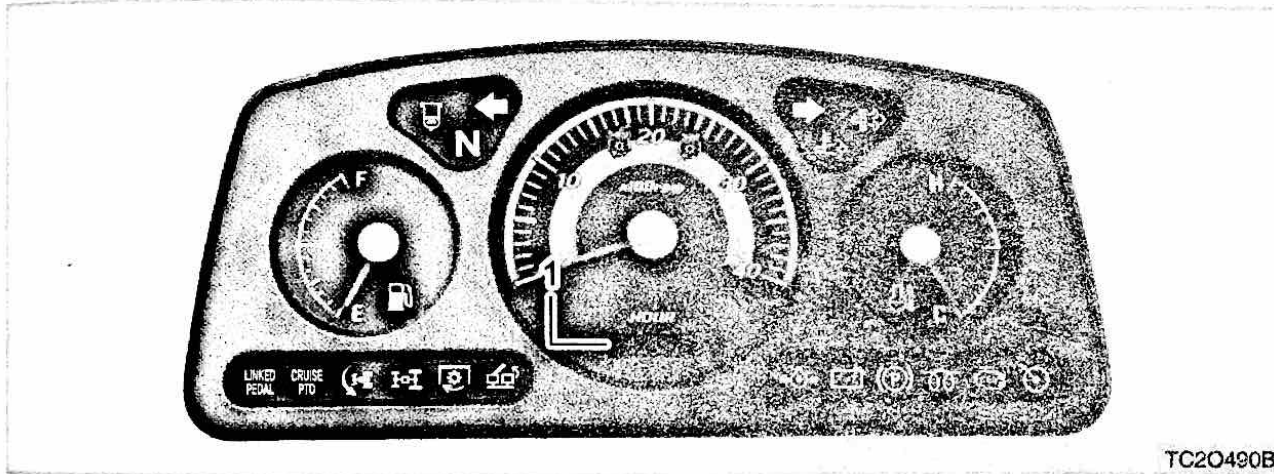

(1) Display

You can see the Error code below on the LCD window for Hour meter. When You found these on the LCD, please contact with **KIOTI** dealer.

NO.	DISPLAY	DESCRIPTION
1	ERR-001	No Signal at TACHO Input
2	ERR-002	No Signal at Water Temp
3	ERR-006	No Signal at GLOW LAMP Input
4	ERR-007	No Signal at PTO CRUISE LAMP
5	ERR-008	No Signal at Water IN FUEL Input
6	ERR-009	No Signal at HOUR Input

 **WARNING**

- Contact to local KIOTI dealer.

 **NOTE**

- Some error codes may not be displayed depending on the model.

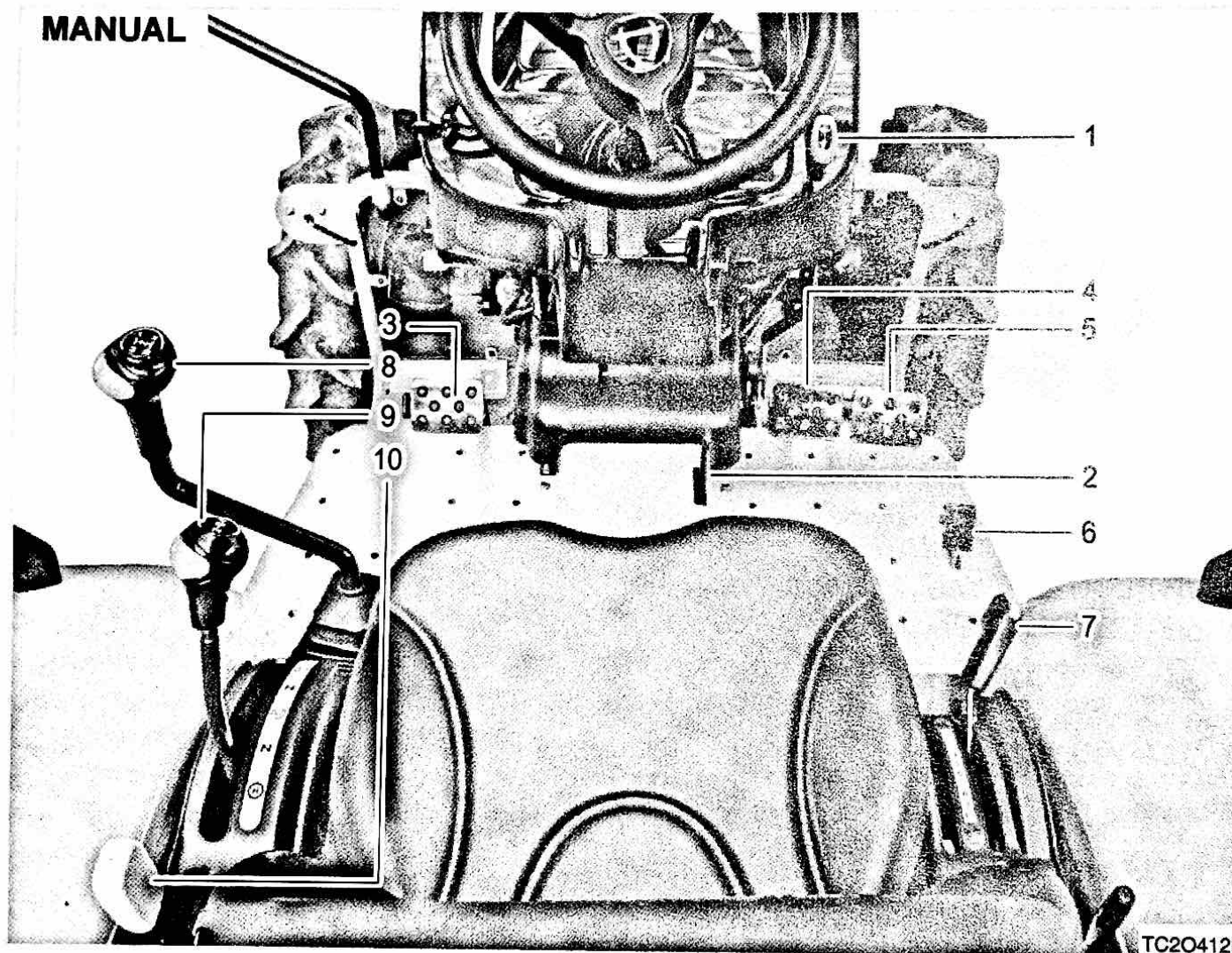
CONTROLS

- (1) Hand throttle lever
- (2) Parking brake release lever
- (3) Clutch pedal
- (4) Brake pedal (LH)
- (5) Brake Pedal (RH)
- (6) Accelerator pedal
- (7) Position control lever
- (8) Main shift lever
- (9) Range shift lever
- (10) PTO shift lever

TC20412B

HST

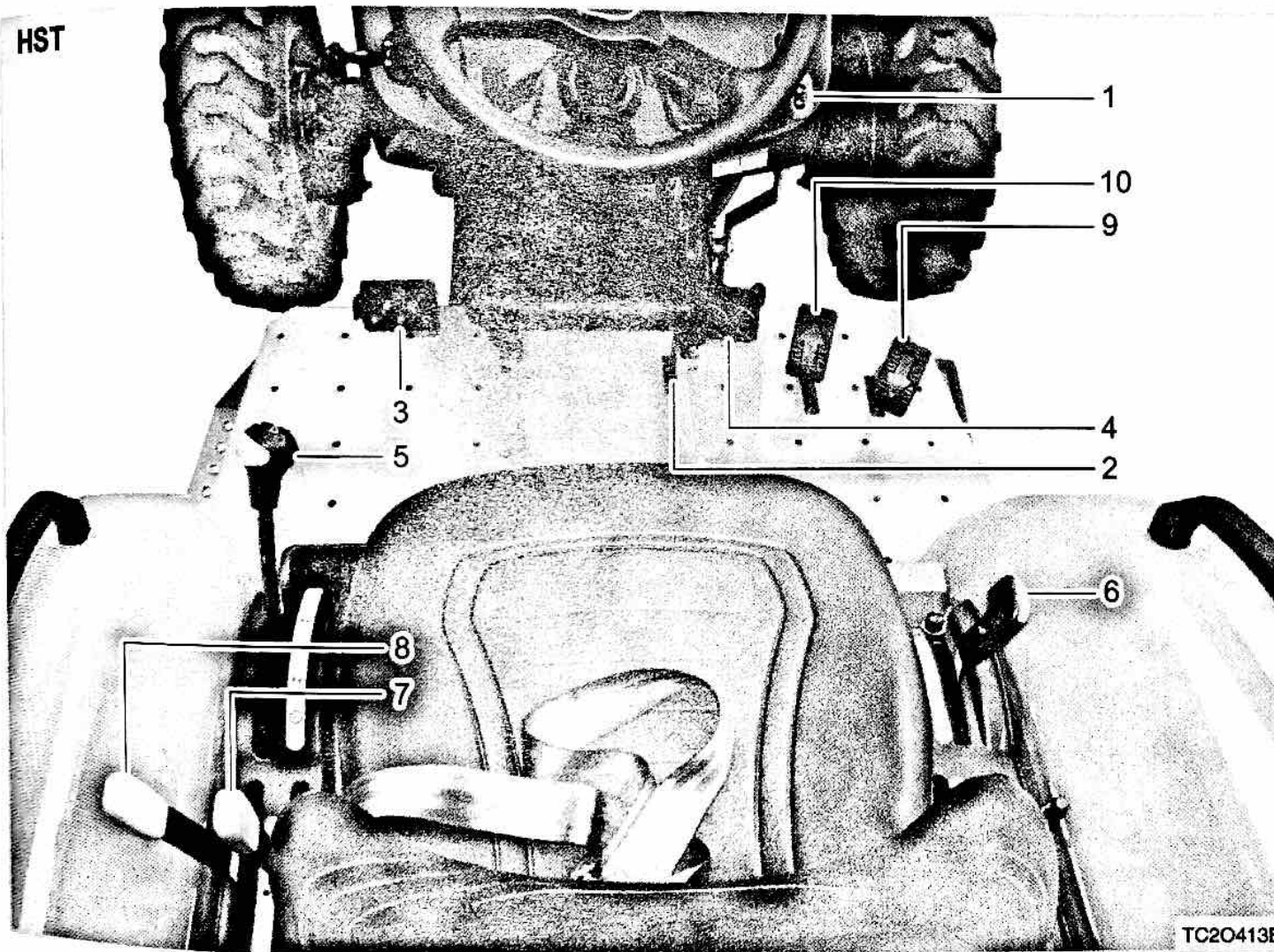

- (1) Hand throttle lever
- (2) Parking brake lever
- (3) Clutch pedal
- (4) Brake pedal
- (5) Range shift lever
- (6) Position control lever
- (7) PTO shift lever
- (8) Mid PTO lever
- (9) HST reverse driving pedal
- (10) HST forward driving pedal

MAIN SHIFT LEVER

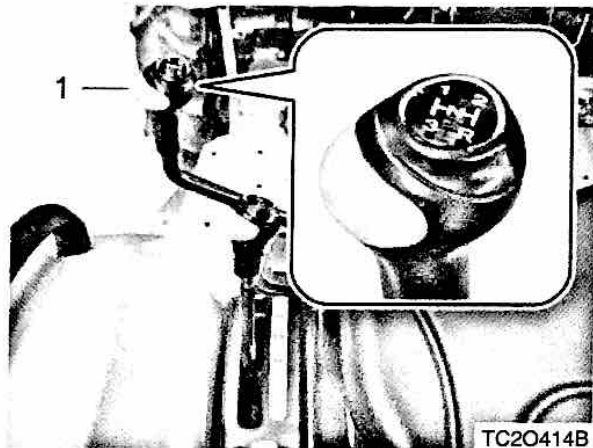

TC20414B

(1) Main shift lever

Three speeds can be selected by moving this main shift lever in "H" shaped path. As the gears are a synchromesh type, gear shifting is possible with the clutch pedal depressed during driving.

In total, 9 forward driving speeds and 3 reverse driving speeds are provided by combination of the main shift lever (Forward 3 speeds, Reverse 1 speed), range shift lever (3 speeds) and shuttle shift lever.

RANGE SHIFT LEVER

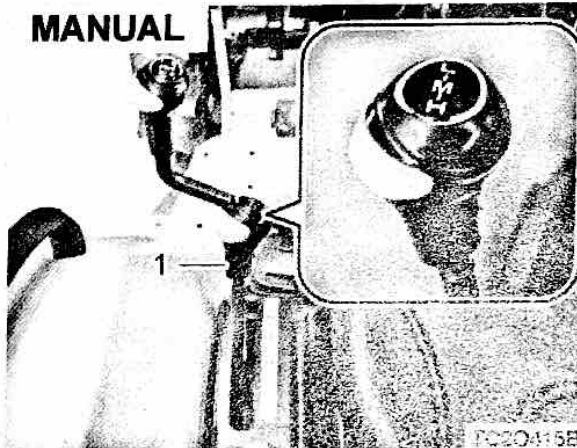

TC20415B

(1) Range shift lever

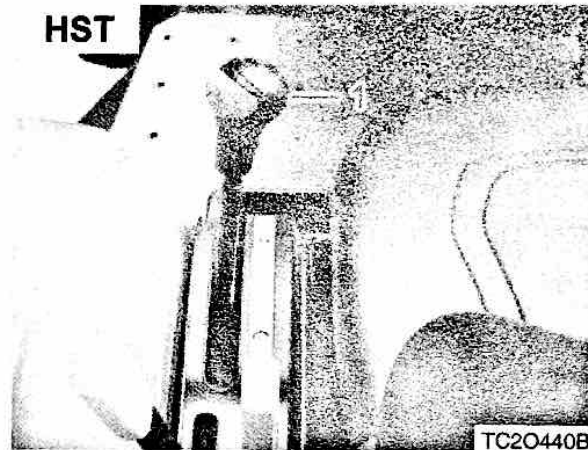

TC20440B

High, mid and low speeds can be selected by the range shift lever. Make sure to shift the range shift lever after the tractor is completely stopped by depressing the clutch pedal.

If the lever is not moved freely or makes abnormal noise, put the lever into the neutral position, engage and disengage the clutch, and then try to shift the lever.

CLUTCH PEDAL

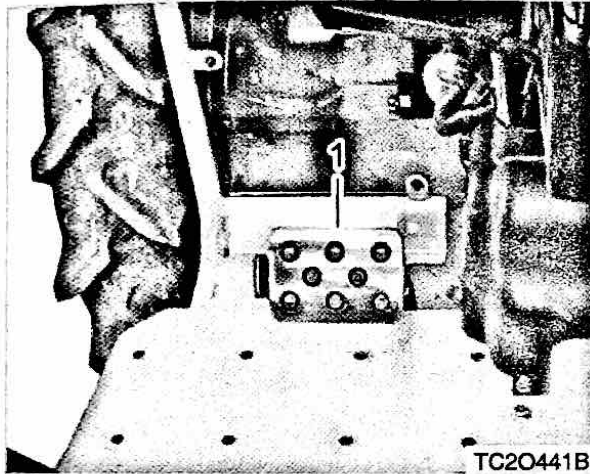

(1) Clutch pedal

Make sure to depress the clutch pedal to its end. To start off smoothly, put the main and range shift levers into the proper positions and release the clutch pedal slowly.

⊕ IMPORTANT

- Never put your foot onto the clutch pedal during driving.
- Be sure to depress the clutch pedal fully when shifting. Otherwise, the shift gear can be broken.

BRAKE PEDAL

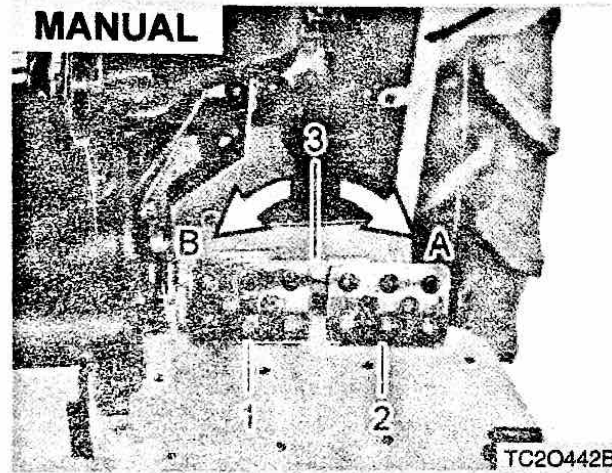

(1) Brake pedal (LH) (2) Brake pedal (RH)
 (3) Pedal Interlock latch
 (A) Engage (B) Disengage

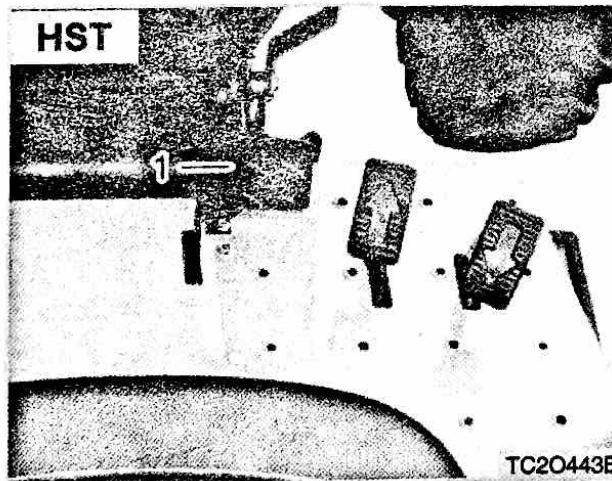

(1) Brake pedal

1. Make sure to latch the left and right brake pedals as shown in the figure while driving on a road. The tractor can roll over if depressing only one brake pedal at a high speed.
2. To make a sharp turn in a work field, disengage the left and right brake pedals to use one of brake pedals separately. Unlock the brake lock, and then turn the steering wheel while depressing the brake pedal on the turning side.

⚠ WARNING

- **Interconnect the left and right brake pedals to avoid rollover or crash during driving or moving in or out of a field.**
- **Avoid sharp turn and braking at a high speed even in the work field. Otherwise the tractor can be rolled over.**

PARKING BRAKE

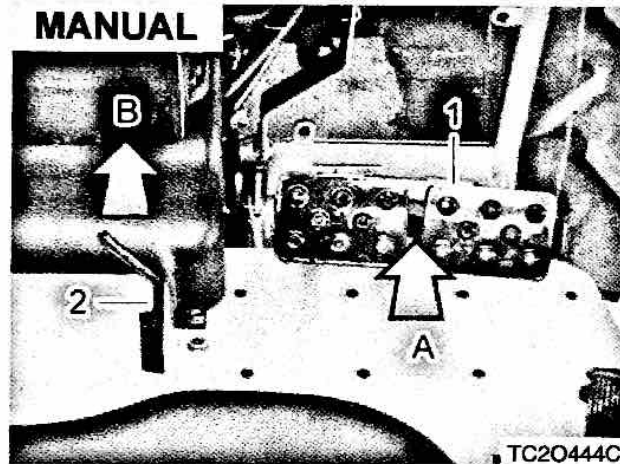

(1) Brake pedal
(A) Depress

(2) Parking Brake Lever
(B) Depress

When you depress the parking brake lever with the left foot while depressing fully on the brake pedal with the right foot, the parking brake will engage.

Depress the brake pedal fully to release the brake.

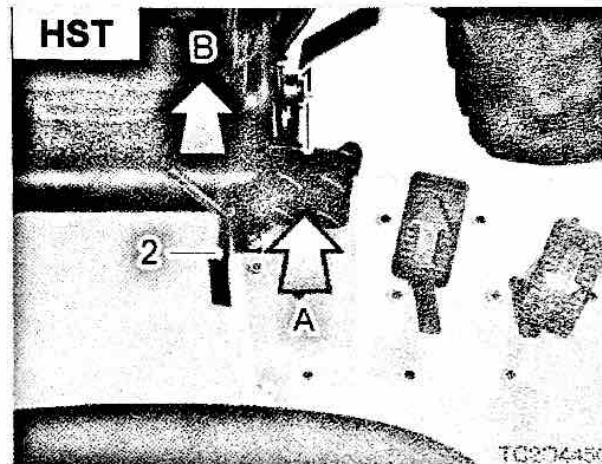

(1) Brake pedal
(A) Depress

(2) Parking Brake Lever
(B) Depress

WARNING

To avoid possible injury, death or loss of property from a machine runaway:

- With the engine off, the tractor may move unexpectedly regardless of the gear shift position. Before leaving the tractor, certainly apply the parking brake to prevent machine runaway.

CAUTION

- If the vehicle is driven with the parking brake partially or completely engaged, it may cause early wear of the brake disc.

ACCELERATOR PEDAL

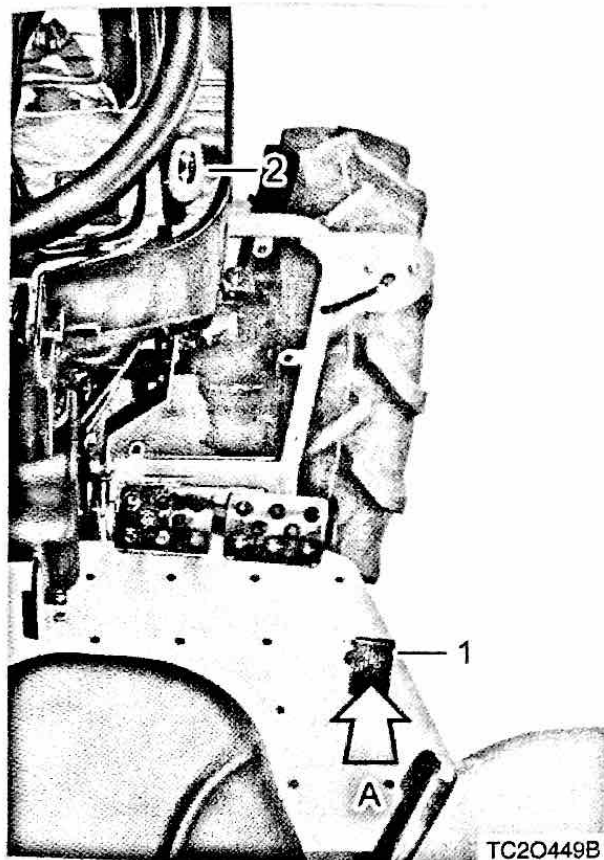



- (1) Accelerator pedal
- (2) Hand throttle lever
- (A) Depress

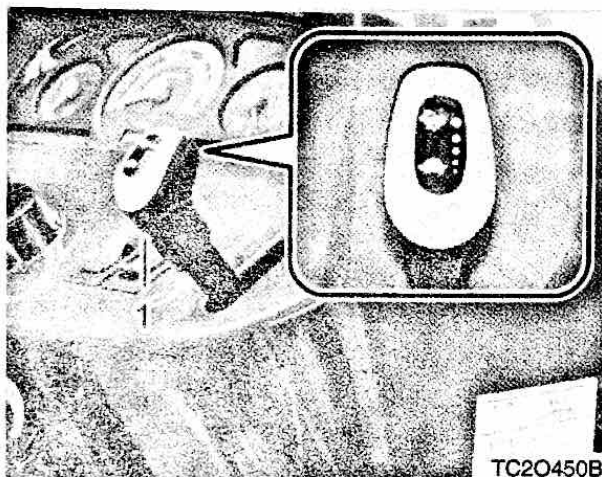

The accelerator pedal is mainly used during driving on a road while the hand throttle lever is mainly used in work field.

HAND THROTTLE LEVER



- (1) Hand throttle lever
-  : Slow
-  : Fast

The hand throttle lever is to control the engine rpm.

The engine accelerates to its full speed by pushing the hand throttle lever ( position) completely out while pulling the lever ( position) decelerates the engine.

The hand throttle lever is mainly used while working on a field.

CAUTION

- Do not use the hand throttle lever while driving on a public road. Otherwise, it can lead to an accident as it becomes hard to decelerate the tractor rapidly.

DIFFERENTIAL LOCK PEDAL

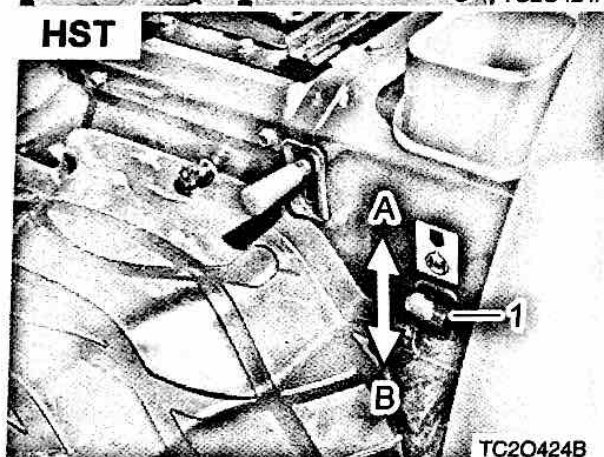
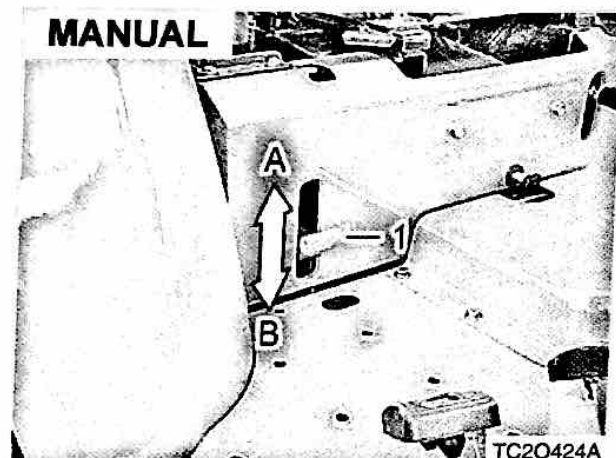

(1) Differential Lock Pedal

(A) Release to disengage

(B) Lock

The differential lock is to secure the differential system and keep the wheel rotation on both sides the same in order to enhance the traction of the rear axle.

Depressing the pedal engages the differential lock while releasing the pedal disengages the differential lock. Use this system under the following conditions:

1. When any wheel slips and the tractor does not move in the field.
2. When it is hard to escape a soft or muddy field.

(REF: This D/L pedal is located to left side on the step floor For HST model.)

⚠ CAUTION

- The differential lock should be engaged only while the driving clutch is engaged. If the differential lock pedal does not move when depressing it, try to depress it again after releasing it.
- When engaging the differential lock, reduce the engine speed. After engaging it, accelerate the tractor.
- Make sure to set the steering wheel in the straight ahead position while the differential lock is in use. Otherwise, the differential system can be damaged.

SEAT ADJUSTMENT SEAT SLIDING

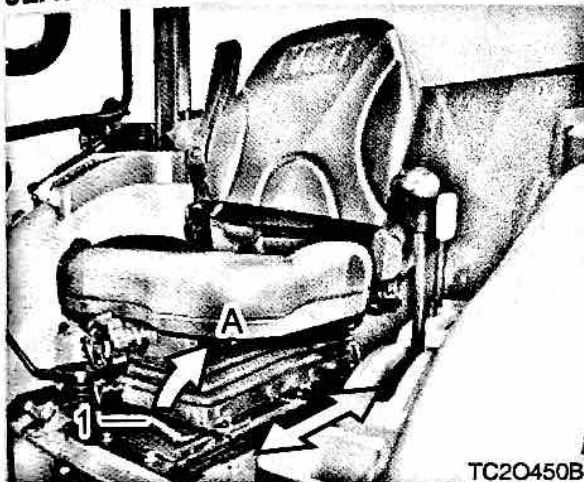

- (1) Seat Adjustment Lever
(A) Pull

To adjust the seat position, pull up the lever (1) under the front of the seat, slide the seat to the desired position, and then release the lever.

Make sure that the seat is firmly fixed by moving it gently after adjustment.

⚠ CAUTION

- Do not put a hand between the seat and the slides when adjusting the seat position. You can get injured unexpectedly.

SEAT BELT



- (1) Seat belt
(2) Release button
(A) Release

The seat belt is a self-retracting type. Make sure to fasten the seat belt before driving.

⚠ WARNING

- Always fasten the seat belt when the tractor has ROPS properly. Otherwise, never wear the seat belt.

⚠ WARNING

- Make sure that the seat belt is not twisted. It cannot work properly, leading to a dangerous situation.
- The seat belt should go around your body as low as possible, not your waist or abdomen. Otherwise, the seat belt cannot protect you properly.

POSITION CONTROL LEVER

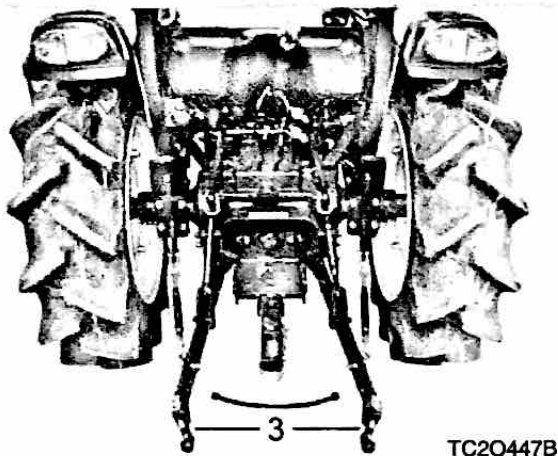
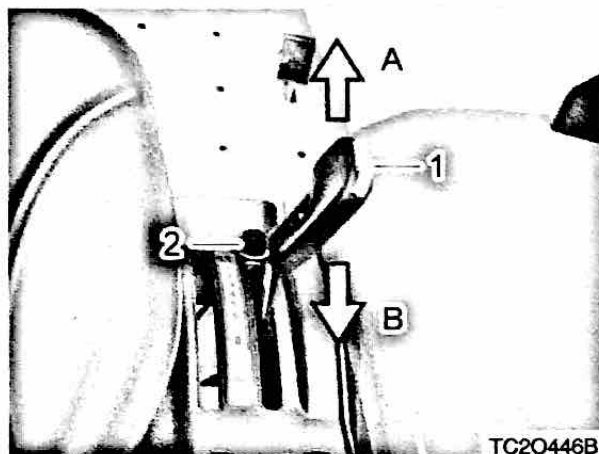

- (1) Position control lever (2) Lock bolt
 (3) Lower link
 (A) Lowering (B) Lifting

The position control lever is used to adjust the height of implements on the 3-point hitch ends.

The implement attached to the lifting arm can be lowered by pushing the lever while the implement is raised by pulling the lever.

In order to limit the lowering height of implements, use the lock bolt (2) to limit the operating range of the lever.

For detailed information, refer to "How to drive" in Chapter 5.

LIFTING ARM (LOWER LINK) SPEED CONTROL KNOB

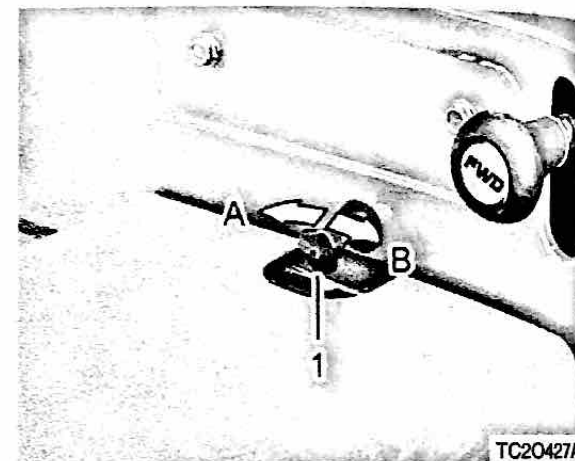

- (1) Lowering Speed Control Knob
 (A) High speed (B) Low speed

Turning the knob counterclockwise increases the lowering speed while turning it clockwise decreases the lowering speed. Also, turning it clockwise to its end can fix the implement to a certain position.

NOTE

- This knob does not control the lifting speed of the lift arm.

PTO SHIFT LEVER

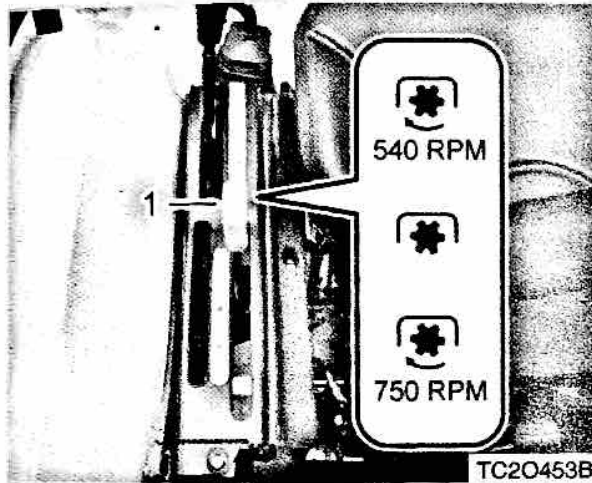

(1) PTO Shift Lever

 : OFF  : ON

PTO shifting needs clutch operation. Press the clutch pedal down completely to stop the tractor movement and any PTO driven equipment movement before shifting the PTO gear shift lever.

ITEM	PTO rpm	
	1st	2nd
US / AU	540	-
EU / TH	540	750

CAUTION

To prevent injuries:

- When connecting, disconnecting or cleaning any PTO driven equipment, stop all rotating parts, stop the engine and disengage the PTO.

IMPORTANT

- Never rest your foot on the clutch pedal during driving. The clutch disc can be rapidly worn.
- Depress the clutch pedal fully during shifting. Otherwise, the life of the shift gear can be reduced.

NOTE

- There is a mark for 540 RPM on the speedometer.

DOUBLE ACTING LEVER (OPTIONAL)

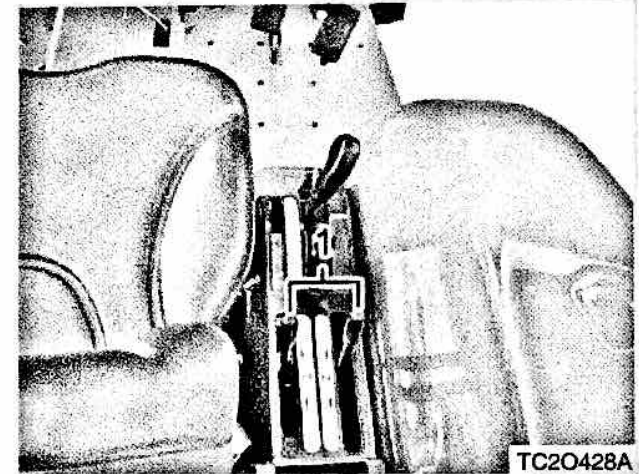

(1) Double acting lever

This lever is used to control a auxiliary hydraulic implement installed to rear.

See the chapter 5, "How to drive" for the details.

LINKED PEDAL LEVER (OPTIONAL)

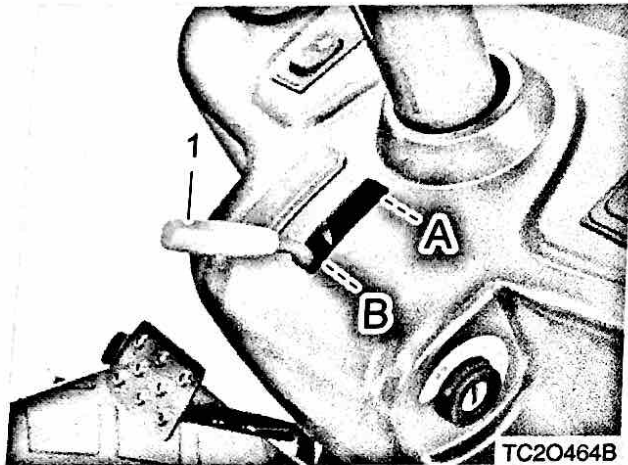

(1) Linked Pedal Lever
(A) ON (B) OFF

When placing the linked pedal lever in the "ON" position, the engine rpm is synchronized with the HST driving pedal.

- 1) Depressing the HST forward/reverse driving pedal: Increase engine RPM.
- 2) Releasing the HST forward/reverse driving pedal: Decrease engine RPM.

⚠ CAUTION

In abnormal driving condition, such as rapid acceleration or deceleration, is occurred by operating the HST pedal, not by other functions such as the load match, speed synchronization and cruise control, follow the following steps immediately.

- 1) Release the driving pedal.
- 2) Depress the brake pedal to its end.
- 3) Turn the ignition switch to the "OFF" position.

Stop the tractor by performing the steps above.

7-PIN SOCKET (OPTIONAL)

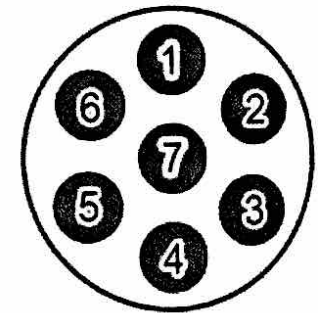
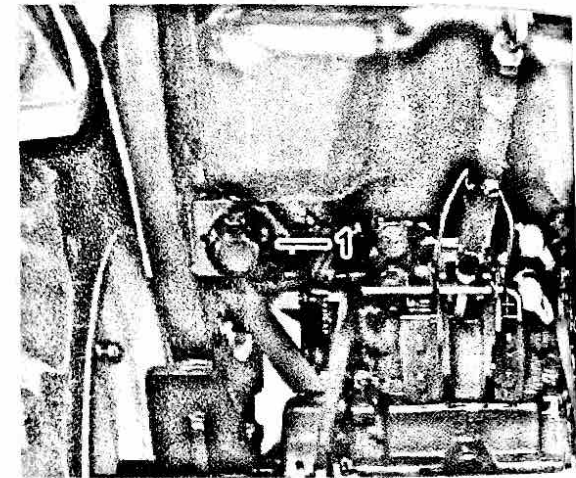

(1) Power connector

The 7-pin socket is installed on the rear left side of the tractor. This supplies power to the brake lamps, turn signal lamps, and position lamps of the trailer.

No.	Circuit	Color of wire
1	Ground	W
2	Spare	B
3	Turn signal lamp (LH)	Y
4	Stop lamp	R
5	Turn signal lamp (RH)	G
6	Tail lamp	BR
7	Spare	L

⚠ WARNING

- *When driving on a road with an implement which has exterior lamps, such as a trailer, make sure to turn on those lamps by connecting them to the 7-pin socket in order to prevent an accident.*
- *Make sure to check for proper operation after connecting the 7-pin socket to the trailer. It may not operate depending on the trailer specifications. Consult your local KIOTI Dealer for this issue.*

TIRES

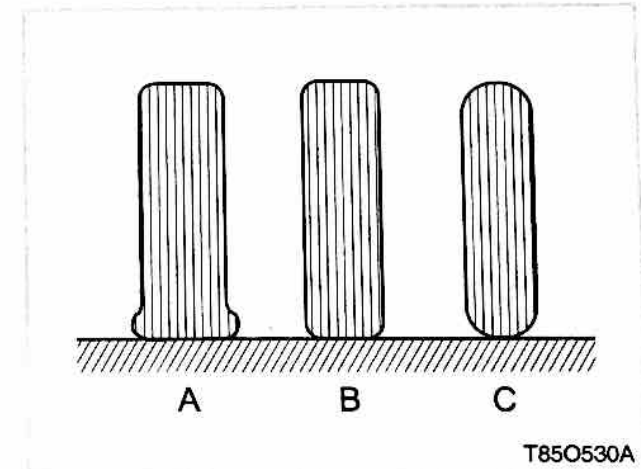

(A) Insufficient
(C) Excessive

(B) Standard

Though the tire pressure is factory-set to the prescribed level, it naturally drops slowly in the course of time.

Thus, check it everyday and inflate as necessary.

⚠ WARNING

- *Do not use tires larger or smaller than specified.*

⚠ WARNING

- *Do not disassemble or assemble the tire. If it is necessary to disassemble/assemble the tire, let a qualified titan service person perform the work.*



T46W030A

⚠ WARNING

- *The tire rims can fall out of the tires. Therefore, stay out of their way when checking or inflating tires.*

INFLATION PRESSURE

Always maintain the proper tire inflation pressure. Make sure the tire pressure does not exceed the pressure recommended in the manual.

Item		CK2610(H) / CK3510(H) / CK4010(H,F,HF)		Remarks
		Tire size	Inflation pressure	
Agricultural	Front wheel	7-16 / 6PR	2.2 kg/cm ² , 215 Kpa, 31 psi	
	Rear wheel	11.2-24 / 4PR	1.6 kg/cm ² , 152 Kpa, 22 psi	
Turf	Front wheel	25 x 8.5-14	-	
	Rear wheel	13.6-16	-	
Industrial	Front wheel	US: 27 x 8,5-15	4.2 kg/cm ² , 413 Kpa, 60 psi	
		EU: 25 x 8,5-14	3.2 kg/cm ² , 310 Kpa, 45 psi	
	Rear wheel	15-19.5	2.9 kg/cm ² , 280 Kpa, 41 psi	

NOTE

- Keep the front tire pressure to maximum when using the front end loader or front suitcase weights.
- If tires with a different size from the ones above mentioned in the table are installed, contact the **KIOTI** dealer for the front/rear wheel speed ratio. Improper front/rear wheel speed ratio can result in excessive wear of tires.

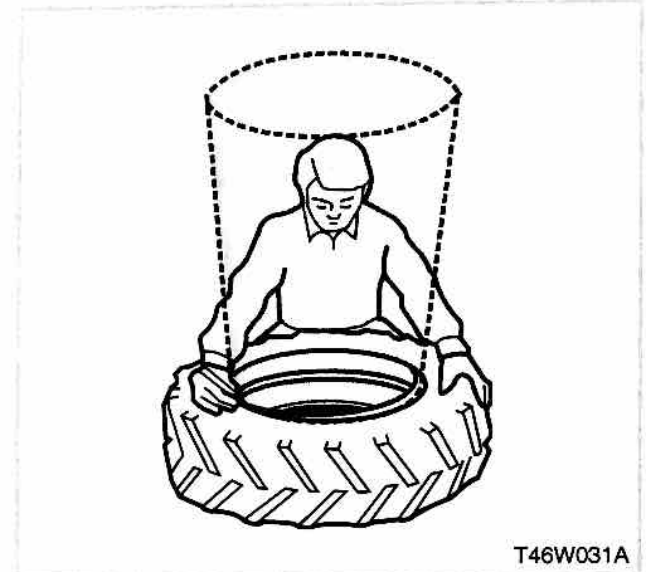

WARNING

- *Do not weld or apply heat to the tire rim or disc. The tire can explode due to the rapidly increased pressure in the tire.*
- *Check tires for inflation pressure, damage, deformation, and excessive wear on lug and damage of rim and disc. Also check if wheel bolts, rim bolts, and nuts are loose.*

TREAD

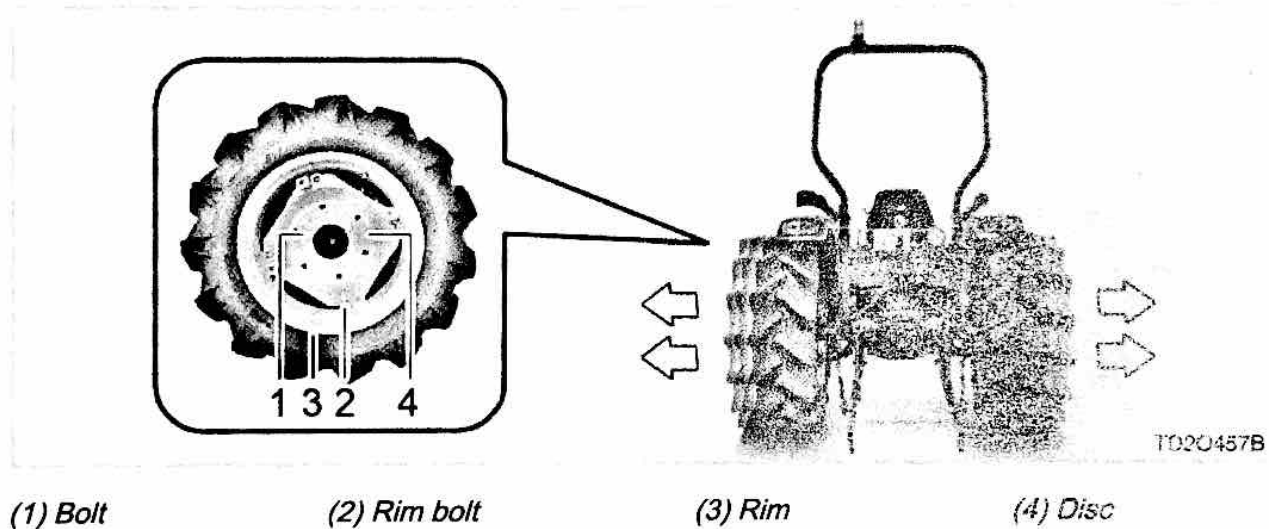

When working on a field where crops are linearly aligned, the tread should be adjusted so that the tires do not cross over the crops. Also, it is necessary to increase the tread to prevent any accident when working on a slope or trailing.

⚠ WARNING

Never operate the tractor with a loose rim, wheel, or axle.

- ***Always tighten nuts or bolts to the specified torque.***
- ***Make sure to perform inspection daily.***

STANDARD TREAD DIMENSION

in. (mm)

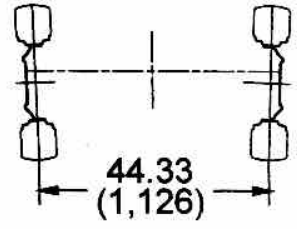
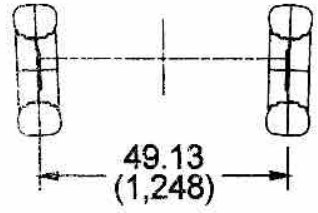
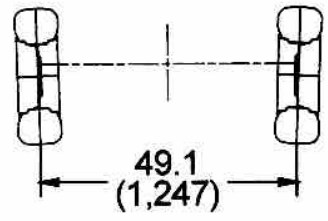
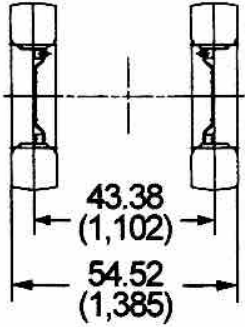
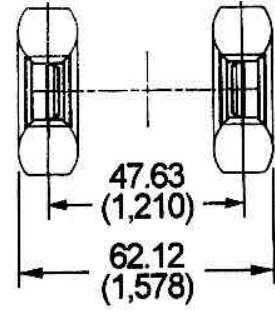
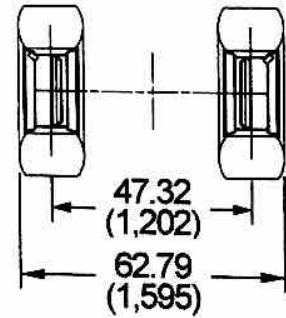
WHL	Agricultural	Turf	Industrial
FRONT	 <p>44.33 (1,126)</p>	 <p>49.13 (1,248)</p>	 <p>49.1 (1,247)</p>
REAR	 <p>43.38 (1,102)</p> <p>54.52 (1,385)</p>	 <p>47.63 (1,210)</p> <p>62.12 (1,578)</p>	 <p>47.32 (1,202)</p> <p>62.79 (1,595)</p>

WHEEL TORQUE AND DIRECTION FRONT WHEEL INSTALLATION PATTERN

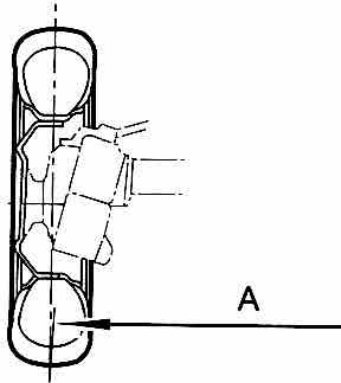

T85O535A

(A) Tread

Front tread can not be adjusted. If it is necessary to adjust it, contact your local KIOTI Dealer.

If it is damaged by unapproved modification, it will not be covered by warranty.

FRONT TIRE SPECS AND WHEEL BOLT/NUT TORQUE

TIRE SIZE
Agricultural
7-16 / 6PR
Tightening torque of wheel bolt (nut)
7.9~9.2 kgf·m
57~67 lbf.ft
77~90 N.m

⚠ WARNING

- **Use tires approved by KIOTI only.**
- **Assemble the tire as shown in the figure.**
- **Contact your local KIOTI Dealer if it is necessary to change the tire specification or installation method.**

REAR WHEEL INSTALLATION PATTERN

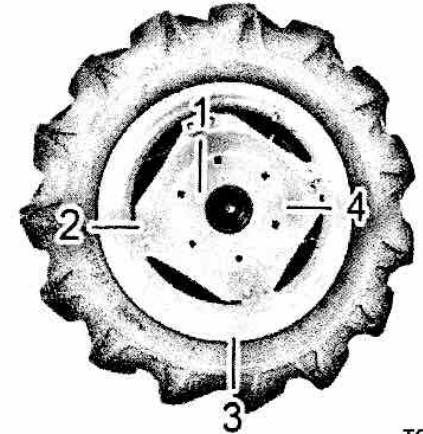

TC2O429A

(1) Wheel bolt
(3) Rim

(2) Rim bolt
(4) Disc

WHEEL INSTALLATION DIRECTION

For agricultural tires, make sure to install them with their arrow marks on their side pointing the front driving direction.

The tire is correctly installed if the tread mark "V" on the ground is shown correctly, not up side down, while the tractor is moving forward.

REAR TIRE SPECS AND WHEEL BOLT/NUT TORQUE

TIRE SIZE

Agricultural

11.4-24 / 4PR

TIGHTENING TORQUE

Wheel bolt (nut)

Rim bolt

20~23 kgf·m
144~166 lbf.ft
196~226 N.m

⚠ WARNING

- Use tires approved by KIOTI only.
- Assemble the tire as shown in the figure.
- Contact your local KIOTI Dealer if it is necessary to change the tire specification or installation method.

ADDITIONAL WEIGHT (OPTION) ADDITIONAL FRONT WEIGHT



TC2Q459B

(1) Additional Front Weight

If the front tires are excessively loaded, it becomes hard to steer the tractor, the tires can be worn faster and the durability of the front axle can be deteriorated.

If the loader is not installed, attach a weight to the front frame of the tractor as a safety measure.

If a heavy implement is installed at the rear or when towing a heavy trailer, the front wheels may be lifted. Add sufficient weight to keep steerability and to prevent rollover.

If sufficient weight, such as a front loader, is applied to the front wheels, remove the additional front weight.

COMPONENTS FOR ADDITIONAL FRONT WEIGHT

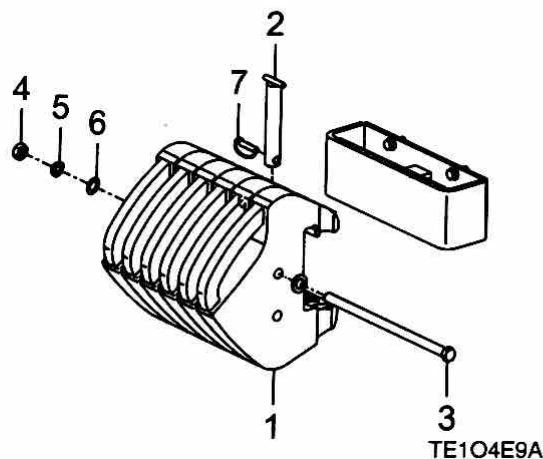

- (1) Front weight
 (2) Retaining pin
 (3) Front weight bolt
 (4) Nut
 (5) Spring washer
 (6) Plain Washer
 (7) Clip pin

When installing or removing a weight, always check the tire inflation pressure and adjust it as necessary.

The front weights are available at the **KIOTI Dealer**. For required number of weights, consult your local **KIOTI Dealer**.

MAX. LOAD

343 lbs. (26 kg × 6 Pieces)

⚠ CAUTION

- Additional weight might be needed for transporting heavy implements.
- Reduce the speed regardless of additional weight when driving on a bumpy or rough road with the implement lifted. The tractor can roll over.

⊕ IMPORTANT

- Attach only required amount of weight.
- The durability of the axle and tires can be degraded.

ADDITIONAL REAR WEIGHT (OPTION)

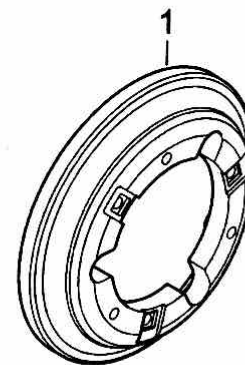

H11O4E1A

(1) Rear Weight

The rear weight is used to maximize the traction of the tractor by increasing the grip of the rear wheels when using a heavy trailer or plow.

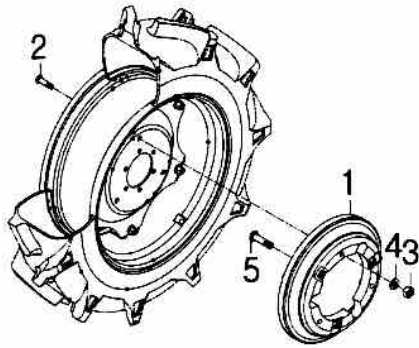

H1104E2B

- (1) Rear weight (2) Weight bolt
 (3) Nut (4) Spring washer
 (5) Bolt

For detailed information on installation, contact your local **KIOTI** Dealer.

MAX. LOAD

220 lbs. (25 kg x 4 Pieces)

⊕ IMPORTANT

- Attach only required amount of weight.
- Unnecessary weight can result in poor braking performance, rapid wear of the brake discs, shortened axle life, and increase in fuel consumption.

HOW TO DRIVE

PRE-OPERATION CHECK.....	5-2
INITIAL OPERATION.....	5-2
OPERATING THE ENGINE	5-3
STARTING ENGINE	5-3
STOPPING ENGINE	5-7
WARMING UP	5-7
JUMP STARTING	5-8
OPERATING THE TRACTOR.....	5-9
HOW TO DRIVE	5-9
HOW TO FOLD ROPS	5-13
HOW TO RAISE ROPS TO UPRIGHT POSITION.....	5-15
PARKING.....	5-15
TURNING	5-17
DRIVING ON SLOPE	5-17
PRECAUTIONS WHEN COMING IN AND OUT OF WORK FIELD	5-18
PRECAUTIONS WHILE DRIVING ON THE ROAD	5-18
LOADING INTO AND UNLOADING OUT OF THE TRUCK	5-19
PRECAUTIONS WHEN USING POWER STEERING	5-20
3-POINT HITCH CONTROL POSITION CONTROL	5-22
REMOTE HYDRAULICS	5-24

PRE-OPERATION CHECK

It is a good practice to know the condition of your tractor before you start it. You should do routine check before each use.

CAUTION

- **Park the tractor on the level ground, stop the engine, and apply the parking brake before checking or repairing it.**
- **Refer to "Daily check item" in Chapter "Maintenance" for fueling.**
- **Be sure to read and understand the information titled as "DANGER", "WARNING", and "CAUTION" thoroughly for the safe operation.**

CHECK ITEMS

- Walk around inspection.
- Engine oil level.
- Transmission oil level.
- Coolant level.
- Clean the front grill and radiator screen.
- Air cleaner element.
- Brake pedal free play.
- All dash gauges and indicators.
- Head lights, tail lights, and working lights.
- Accessible wiring harness for any damage.
- Seat belt, ROPS and cabin for damage.
- Fuel level.
- All "DANGER" and "WARNING" decals.
- Tire pressure and wheel bolt tightness condition.

For detailed information, refer to "Maintenance schedule chart" in chapter 7.

INITIAL OPERATION

Driving a new tractor at a high speed or under heavy load can affect its durability.

Make sure to run the tractor at the proper work load and speed for the initial operation of 10 to 20 hours.

TIPS FOR BREAKING-IN

1. Start the engine and idle the engine at a low speed for 3 to 4 minutes in advance.
2. Increase the idling time in cold weather.
3. Do not drive the tractor at the maximum speed on a road.
4. Never apply excessive load during work.
5. Idle the engine at a low speed for 2 to 3 minutes before stopping it.

OPERATING THE ENGINE STARTING ENGINE

⚠ WARNING

To avoid accidents:

- Be sure to read and understand the warning and caution decals on the tractor thoroughly.
- Run the engine only in a well-ventilated area, or you can be suffocated by exhaust gas.
- Never start the engine unless you are on the driver's seat. The tractor can abruptly start off, resulting in an injury or accident.

⊕ IMPORTANT

- Using an additive so the engine will start more easily can damage the engine. And it will not be covered by warranty.
- Never try to start the engine for over 10 seconds consecutively to protect the start motor and battery from damage.

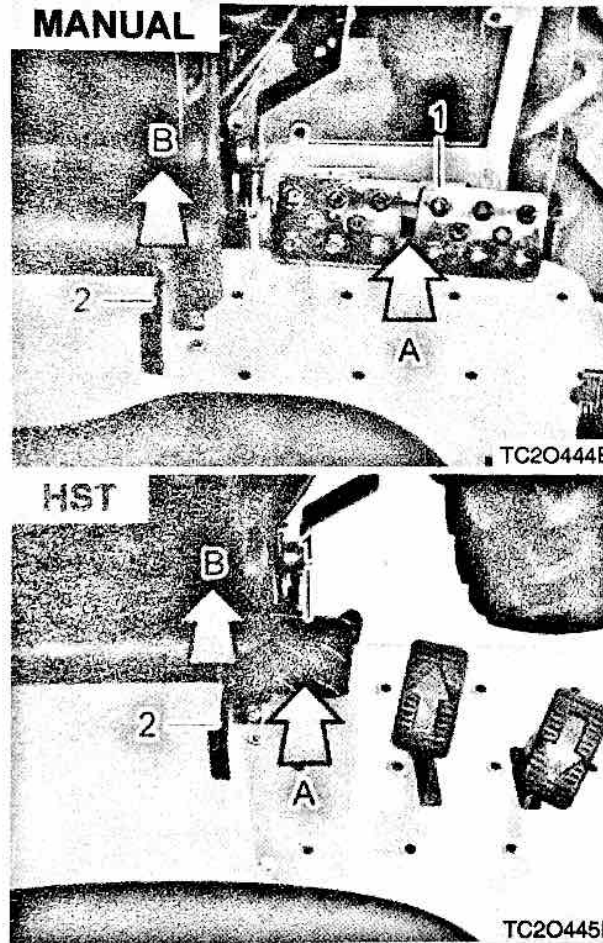

(1) Brake pedal
(A) Depress

(2) Parking brake lever
(B) Depress

1. Make sure there is no obstacle around the tractor.
2. Securely engage the parking brake.

⊕ IMPORTANT

- Make sure that the brake pedals are fully depressed before pulling the parking brake lever up.

 **NOTE**

- When the parking brake is engaged, the parking brake lamp on the instrument cluster illuminates. When releasing it, the parking brake lamp is turned off.

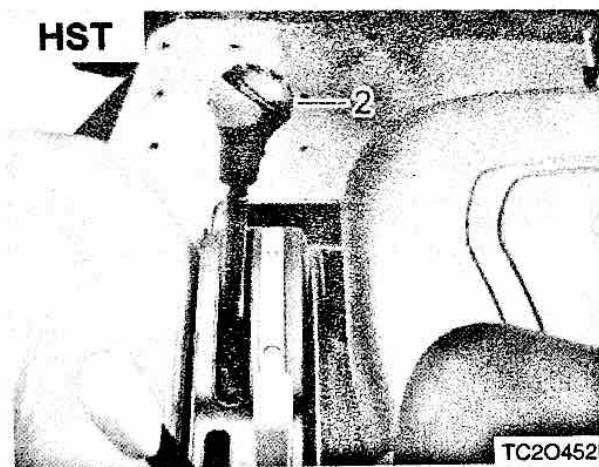
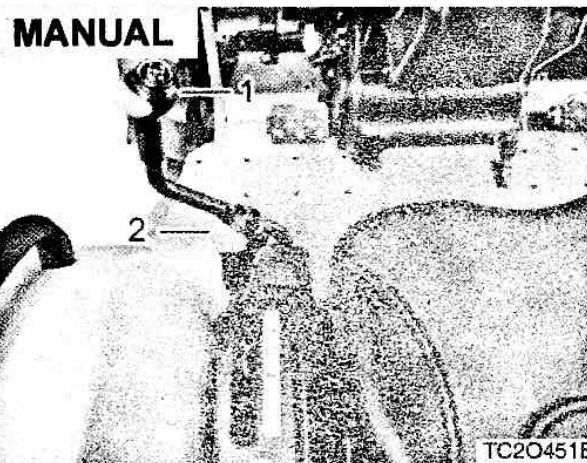

(1) Main shift lever (2) Range shift lever

3. Set the main and range shift levers in the neutral position.

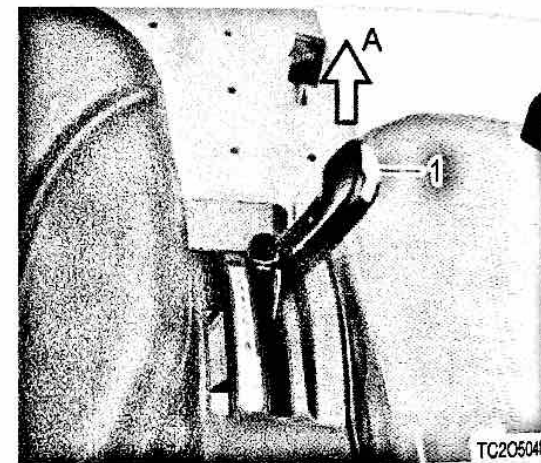

(1) Position control lever
(A) Down

4. Lower the implement by pushing the position control lever forward.

 **WARNING**

- **Make sure that no one is near the implement or behind the tractor.**

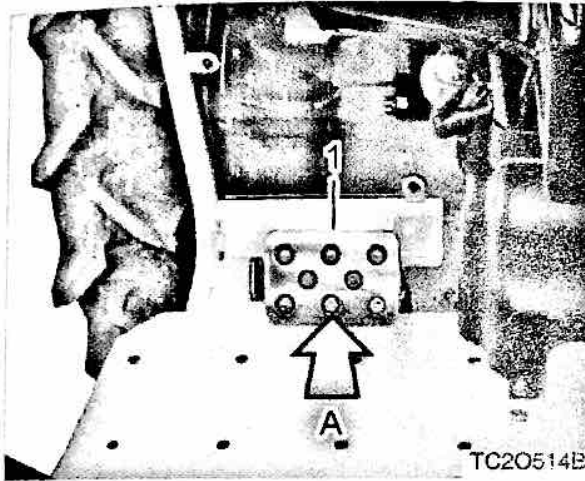

(1) Clutch Pedal
(A) Depress

5. Depress the clutch pedal. (The engine will not start unless the clutch pedal is depressed.)

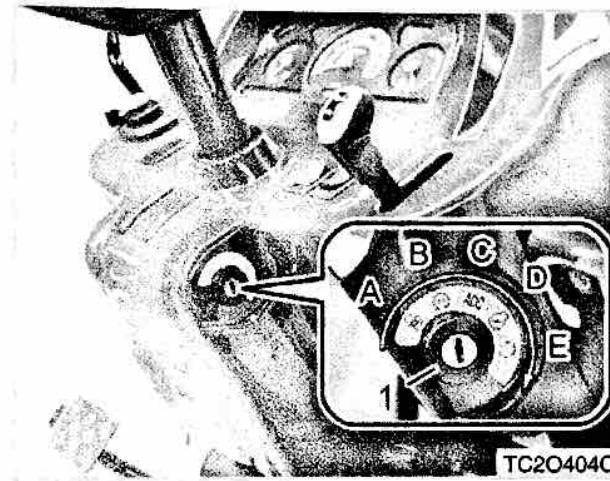

(1) Key switch
(A) Preheat (B) OFF
(C) ACC (D) ON (E) START

6. Insert the key into the key cylinder, turn it to the "ON" position and wait until the preheat indicator goes off (approx. 8 seconds).

If automatic pre-heating is not sufficient, turn and hold the key to the position "A" (manual pre-heating) for a few seconds for manual pre-heating. When the manual pre-heating operation is started, the preheat indicator on the instrument cluster is illuminated.

It is normal that the charge warning lamp and engine oil pressure warning lamp come on when the key is in "ON" position before the engine starts.

⚠ WARNING

- **Never operate the start motor for more than 10 consecutive seconds as it consumes an excess of battery power. If the engine cannot be started within 10 seconds, wait for 30 seconds and try again.**
- **When trying to start the engine again, wait until the flywheel is completely stopped.**

7. When the engine is started, release the key. Then, the key is automatically turned back to the "ON" position.
8. When the engine is started, Warm up the engine for 3 to 4 minutes (10 minutes in winter) after releasing the clutch pedal.

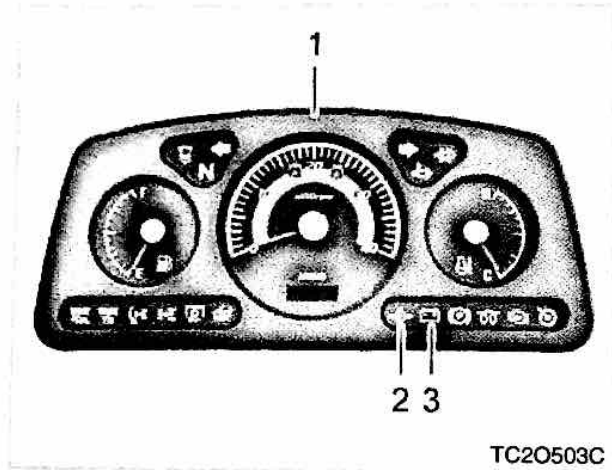

- (1) Instrument cluster
 (2) Engine oil pressure warning lamp
 (3) Charge Warning Lamp

9. Check to see that all the warning lamps on the instrument cluster are turned "OFF."

If any lamp remains on, immediately stop the engine and determine the cause.

CHECKING WARNING LAMPS

1. If the oil pressure warning lamp (2) does not go off in 4 to 5 seconds after the engine is properly started, stop the engine immediately and check the engine oil level. If the engine oil level is proper, contact your local KIOTI Dealer.

⚠ WARNING

- *The engine can be severely damaged if it is run with the oil pressure warning lamp ON.*

2. If the charge warning lamp (3) does not go off in 4 to 5 seconds after the engine is properly started, it means that the battery is not being charged. Have the charging system, such as the battery and alternator, inspected.
3. Refer to "Instrument panel" in chapter 4 for detailed information about other indicators and lamps.

⚠ WARNING

- *If driving the tractor for an extended period of time with the charge warning lamp ON, the battery can be discharged and the tractor's electrical system can be damaged.*

STOPPING ENGINE

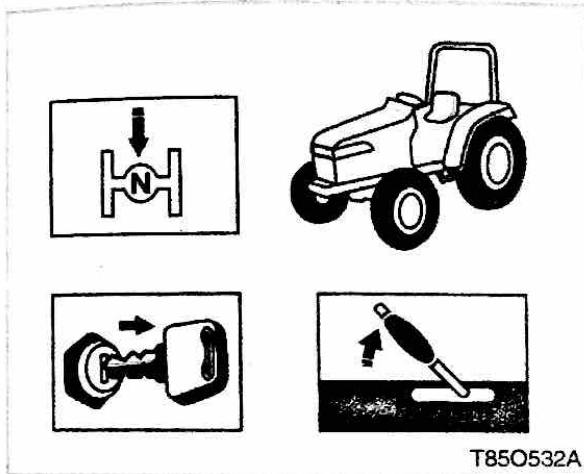

1. Make sure to reduce the engine rpm before stopping the engine.
2. Depress the clutch pedal and put all shift levers in the neutral position.
3. Run the engine at the idle speed for approx. 2 to 3 minutes, and then turn the key switch to the "OFF" position to stop the engine.
4. Remove the key.

 **WARNING**

- *Never touch the muffler or hot covers until they have cooled down after running the engine or driving the tractor.*

 **IMPORTANT**

- Turn off all the electrical devices and remove the ignition key before leaving the tractor.
- Do not leave the tractor outside unattended. It can be stolen, as the key used for all KIOTI tractors are the same in design.
- The horn, turn signal lamp and hazard lamp can be operated without the key inserted. Therefore, using these components without the engine started can discharge the battery.

WARMING UP

It is recommended always to warm up the engine before driving in order to maintain the durability of the engine. Before warming up the engine, make sure that each part in the engine is properly lubricated and each hydraulic part is in a perfect condition in order to prevent malfunction in the engine as well as the hydraulic system.

HOW TO WARM UP ENGINE

1. Start the engine and run it at a low speed and without a load for approx. 3 to 4 minutes.
2. In cold weather, increase the warm up time to 10 minutes.
3. If it is very cold, warm up the engine for approx. 15 minutes.
4. The engine throttle can be open to 50 % in order to shorten the warming up time.
5. The engine is sufficiently warmed up when the temperature gauge on the instrument panel indicates 1/4 of the normal temperature range, regardless of the warming-up time.
6. Do not increase the work load rapidly after starting work.
7. Run the engine without load for approx. 2 to 3 minutes before stopping the engine after work.

⚠ WARNING

- *Warming up the engine excessively increases fuel consumption and affects the durability of the tractor negatively.*
- *Never warm up the engine and leave the tractor for an extended period of time. It can cause fire and an accident.*
- *Never leave the tractor unattended while warming up.*
- *Be sure to apply the parking brake while warming up the engine.*
- *If the warm-up is skipped or missed, the tractor can take off abruptly to cause a fatal accident.*

JUMP STARTING

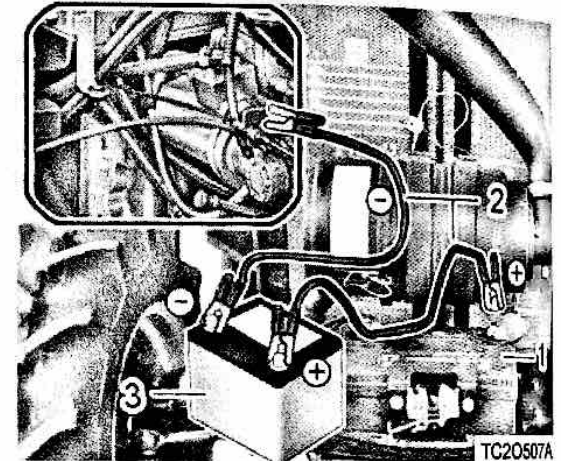

- (1) Dead battery (2) Jump cable
 (3) Helper Battery
 (A) Ground (transmission case)

If the battery is discharged and the engine cannot be started, it is possible to start the engine by connecting the discharged battery to a battery from another tractor or other extra battery.

1. Check that the rated voltage of the discharged battery is same as the voltage of the other tractor or vehicle for jump start. (Specification for this tractor: 12 V)

2. Check the length of the jump cable and position another tractor near the tractor with the discharged battery. Then, put all the shift levers in the neutral position, apply the parking brake, and stop the engine.
3. Wear protective glasses and gloves and open the hoods of both tractors. Remove the battery terminal cover as necessary.
4. Connect the alligator clips on both ends of the red positive cable to the positive terminals of both batteries.
5. Connect one clip of the black negative cable to the negative terminal of the normal battery and the other clip to the tractor body with the discharged battery. Make sure to connect the clip to the body part without paint.
6. Start the engine of the tractor with the normal battery.
7. Start the engine of the tractor with the discharged battery.
8. Disconnect the black cable from the negative battery terminals of both of the tractors.
9. Disconnect the red cable.
10. Run the engine for at least 30 minutes to charge the discharged battery.
11. If the battery is discharged again, replace it or check the charging system, such as the alternator.

OPERATING THE TRACTOR HOW TO DRIVE

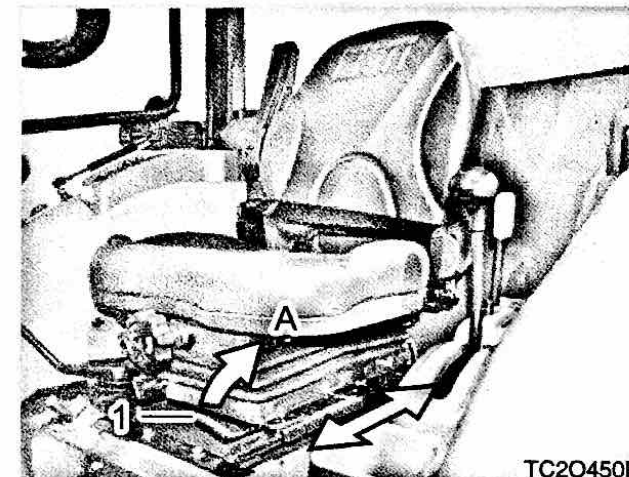

(1) Seat Adjustment Lever
(A) Pull

1. Adjust the seat and fasten the seat belt.

WARNING

- **Check if the seat is securely locked after seat adjustment.**
- **Do not adjust the seat while driving. The seat may move suddenly causing loss of control of the tractor.**

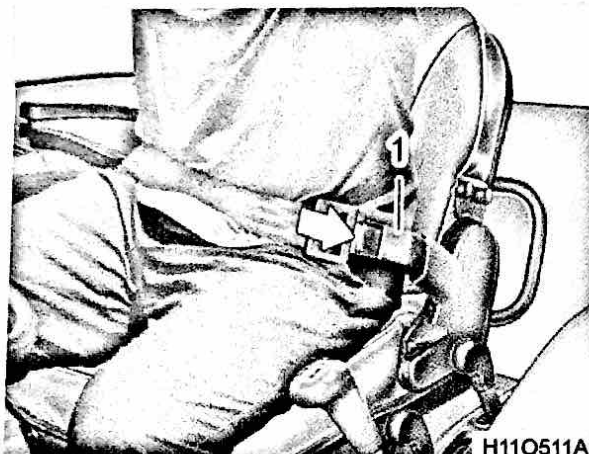

H110511A

(1) Seat Belt

2. Wear the seat belt.

⚠ WARNING

- **Be sure to fasten your seat belt if the tractor is equipped with the ROPS or cabin.**
- **The seat belt should go around your pelvis or as low as possible, not your waist or abdomen. Otherwise, the seat belt cannot protect you properly.**
- **Do not wear the seat belt if the ROPS is not installed or folded down.**

MANUAL

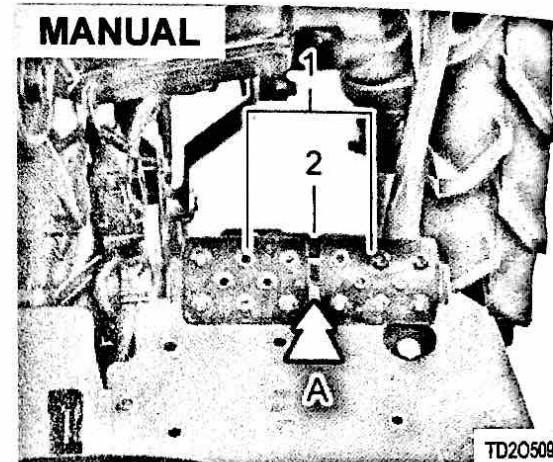

TD20509A

- (1) Brake pedals (LH/RH)
 (2) Brake pedal interlock latch
 (A) Depress

3. Make sure that both brake pedals are interlocked.

⚠ WARNING

- **If depressing only one brake pedal at a high speed, the tractor can lose its balance and be overturned.**

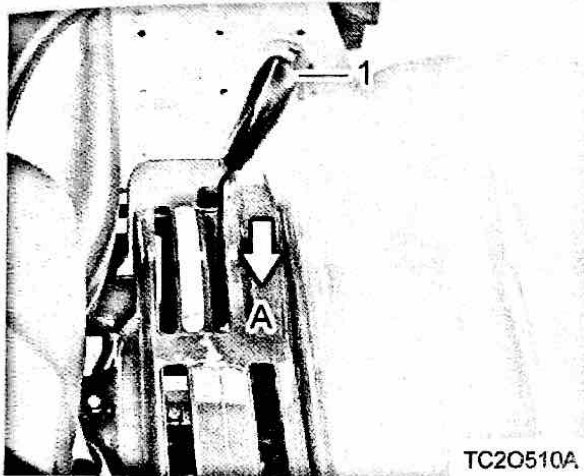

TC2O510A

(1) Position control lever
(A) Lifting



4. Pull the position control lever backward to raise the implement on the 3-point hitch.

NOTE

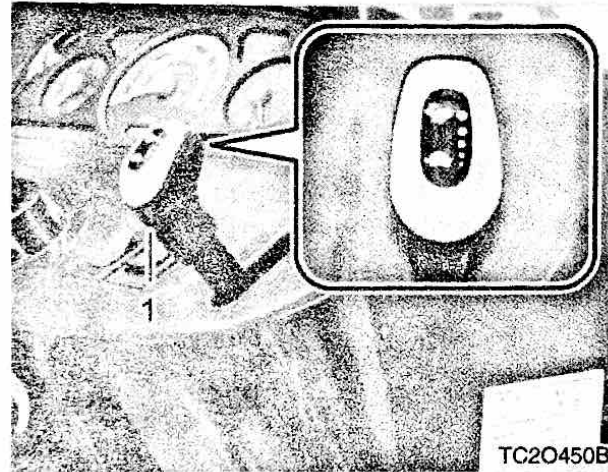
- If the implement won't be lifted, press the one-touch switch (lifting/lowering). Otherwise, lower the position control lever completely and lift it again.



TC2O450B

(1) Hand throttle lever
 : Slow  : Fast

5. Increase the engine RPM slowly from idle speed to medium speed.

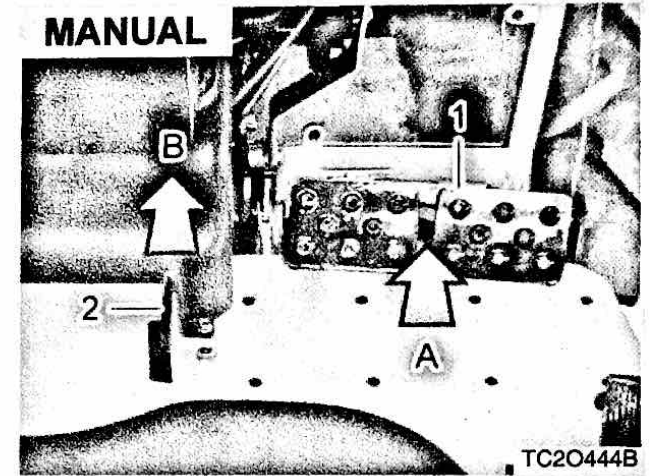

TC2O444B

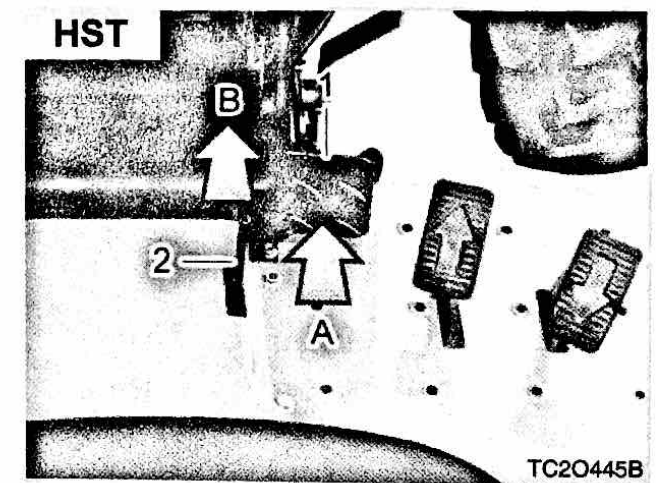

TC2O445B

(1) Brake pedal (2) Parking brake lever
(A) Depress (B) Release

6. Depress the brake pedal to release the parking brake. (HST)

Push the release lever to release the brake.

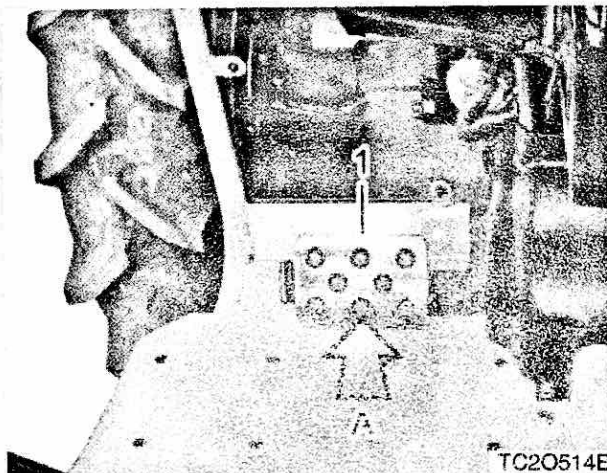

(1) Clutch Pedal
(A) Depress

7. Depress the clutch pedal fully.

⚠ CAUTION

To avoid accidents:

- Do not release the clutch pedal abruptly. The tractor may start off abruptly, resulting in rollover.

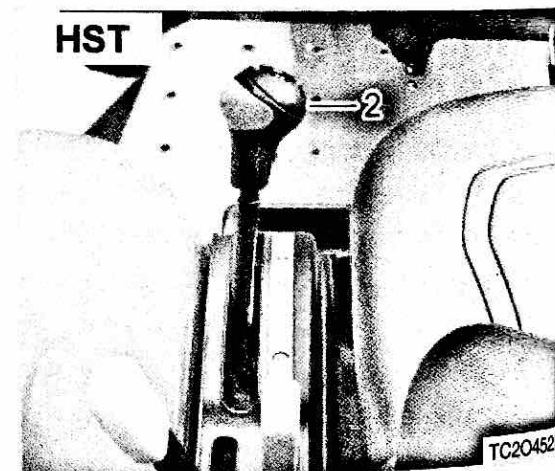
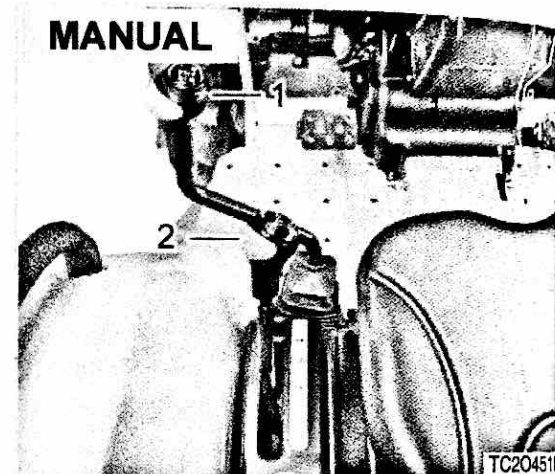

(1) Main shift lever

(2) Range shift lever

8. Move the main and range shift levers into the desired positions. (For the HST model, move the range shift lever to the desired position.)
9. The tractor starts to move if you release the clutch pedal slowly. (For the HST model, the tractor starts to move when depressing the shuttle shift pedal slowly.)

! CAUTION

- **Never put your foot on the clutch pedal during driving. The clutch disc can be rapidly worn.**
- **Make sure to operate the clutch fast when disengaging it and slowly when engaging it.**
- **Do not change the tractor speed abruptly for safe driving.**
- **When driving on a slope or loading or unloading the tractor to a transporting vehicle, reduce the speed in advance so that there is no need to shift the gear in the middle of the slope. Also, do not put your hand on the shift lever while driving on a slope. The tractor may roll down the slope due to the disengaged gear which is very dangerous.**

HOW TO FOLD ROPS

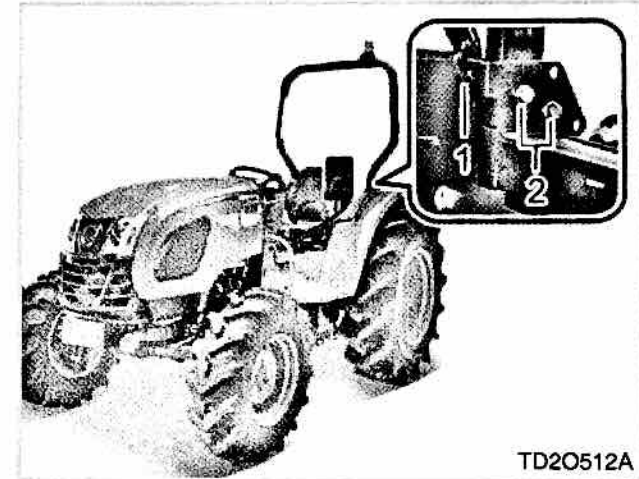

TD20512A

(1) Knock bolt

(2) Mounting bolt

1. Unscrew the knock bolt. Then, loosen the mounting bolts.

! CAUTION

- **You should always stop the engine, remove the key and set the parking brake before raising or folding the ROPS.**
- **Always perform such tasks from a safe and stable position at the rear of the tractor.**

⚠ CAUTION

- It is very dangerous to drive with the ROPS folded. Fold the ROPS only when there is absolutely no possibility for roll over. If the situation changes, raise the ROPS upright immediately.

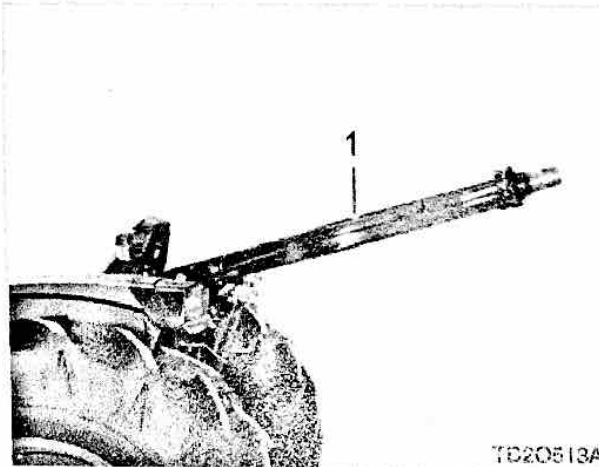

TD20513A

(1) ROPS

2. Fold the ROPS.

⚠ CAUTION**To avoid accidents:**

- Hold the ROPS tightly with both hands and fold the ROPS slowly and carefully.

3. Align the bolt holes and fit the mounting bolt to them.

⚠ CAUTION**To avoid accidents:**

- Fix the mounting bolts firmly and secure the frame with the knock bolt.

HOW TO RAISE ROPS TO UPRIGHT POSITION

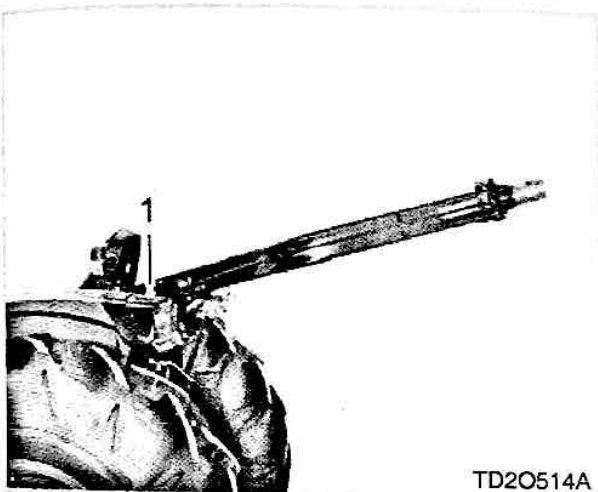

TD2O514A

(1) Mounting bolt

1. Unscrew the mounting bolts.
2. Set the ROPS in the upright position.
3. Align the bolt holes and fit the mounting bolts to them.
4. Tighten the knock bolt and fix it with the nut.

⚠ CAUTION

To avoid accidents:

- Make sure to set the ROPS upright and fasten the seat belt during work. If it is necessary to work with ROPS folded, do not fasten the seat belt. Fastening seat belt with folded ROPS can be dangerous in case of tractor rollover.

⊕ IMPORTANT

- ROPS (Roll Over Protective Structure), sun canopy or cabin are not a FOPS (Falling Object Protective Structure). It never can protect the riders against falling objects. Avoid driving the vehicle into a dangerous area such as falling rocks zone. Otherwise, it may lead to a serious injury.

PARKING

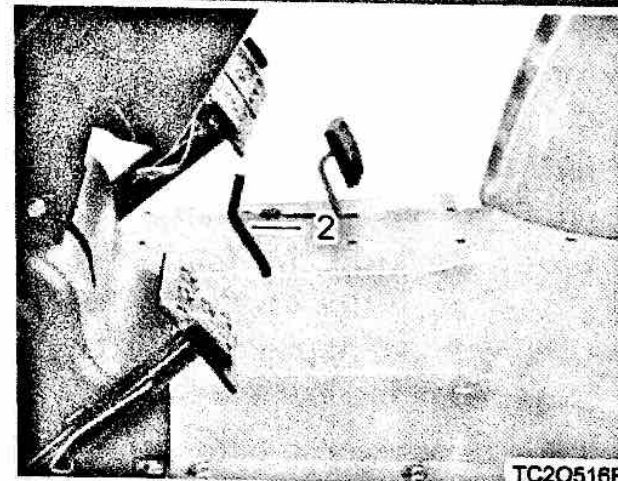
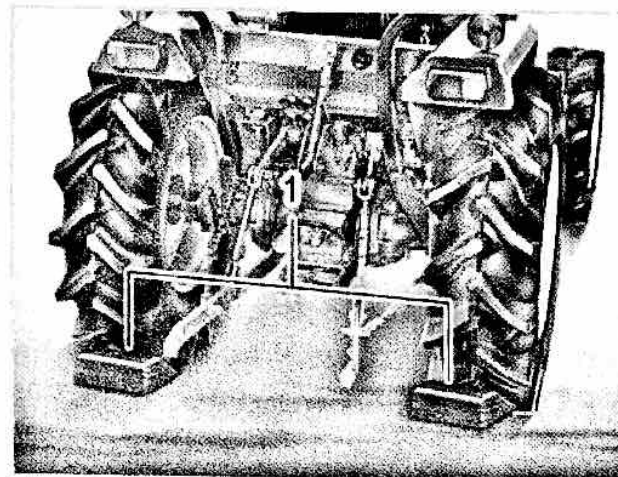

TC2O516B

(1) Block

(2) Parking brake

1. Pull the parking brake lever (2) up with the brake pedals depressed forward to engage the pedals with the latch. If the braking force is insufficient, depress the pedals more firmly.
2. Before leaving the tractor after parking it, make sure to stop the PTO, lower the implement onto the ground, and stop the engine.
3. If it is necessary to leave the tractor with the engine running, put all the shift levers in the neutral position and apply the parking brake firmly.
4. When parking the tractor on a slope, stop the engine with the parking brake applied and all gears engaged in the low speed position.
5. If it is necessary to park the tractor on a slope with the engine running, apply the parking brake and chock all four wheels.
6. To release the parking brake, depress the brake pedals firmly once again.

 **WARNING**

- *The brake pad can be rapidly worn if you drive with the parking brake applied.*
- *Never park the tractor on a steep slope in any circumstance. A severe accident can occur.*

 **WARNING**

To avoid possible injury, death or loss of property from a machine runaway:

- *With the engine off, the tractor may move unexpectedly regardless of the gear shift position. Before leaving the tractor, certainly apply the parking brake to prevent machine runaway.*
- ※ *Only H-shuttle model.*

 **IMPORTANT**

- **Get off the tractor after checking that the tractor is completely stopped and the parking brake is firmly applied.**
- **Do not park the tractor on tall grass or hay. If grass or hay contacts with the muffler, it can catch fire.**

TURNING

You should turn slowly by reducing vehicle speed.

WARNING

To prevent accidents due to loss of steering control:

- *If you turn at high speed, the tractor can turn over.*
- *Never use the differential lock system when turning at high and low speeds. A serious accident can occur.*

DRIVING ON SLOPE

1. Please drive according to the conditions of the slope at safe speed so that the engine is not under heavy load if possible.
2. Make sure to shift to the lower gear in order to prevent the engine from stalling on an uphill.
3. Drive with the low speed gear on a downhill road to facilitate the engine brake.

WARNING

- *Make sure the brake pedals are interlocked and differential lock pedal is released.*
- *Do not disengage the clutch or put the shift lever in the neutral position on a steep slope. Otherwise, the tractor may become inoperable.*
- *Before entering a steep slope, move the shift lever down to a proper gear and never try to move the shift lever on a slope. A serious accident can occur.*

IMPORTANT

- **For a heavy load job, such as front end loader operation, use low speed of the range shift lever.**

PRECAUTIONS WHEN COMING IN AND OUT OF WORK FIELD



T85O536A

1. Make sure that the left and right pedals are interlocked.
2. Enter and exit the field by driving the tractor at a right angle to the bank.
3. It is recommended to use the 4WD and drive backward when moving onto a bank.

PRECAUTIONS WHILE DRIVING ON THE ROAD

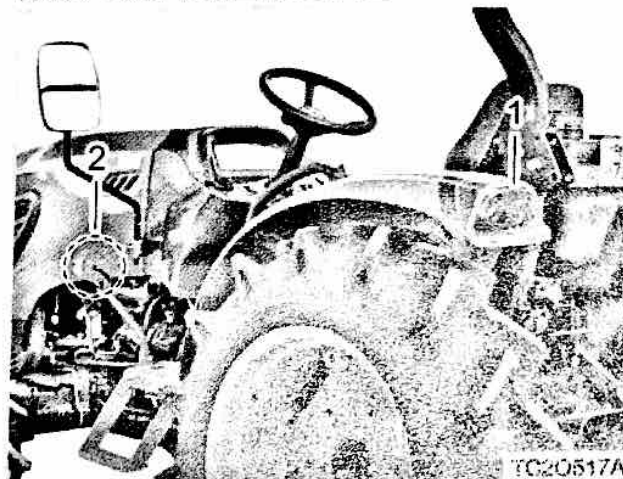

TC2O517A

- (1) Turn signal lamp (RR)
- (2) Turn signal lamp (FRT)

1. When you change the driving direction on a road, let other vehicles know your direction with the turn signal lights.
2. Do not use the high beam headlights when another vehicle is approaching from the opposite direction so that not to interrupt another driver's view.
3. Always interlock the left and right brake pedals while driving on a public road. (Manual)

MANUAL

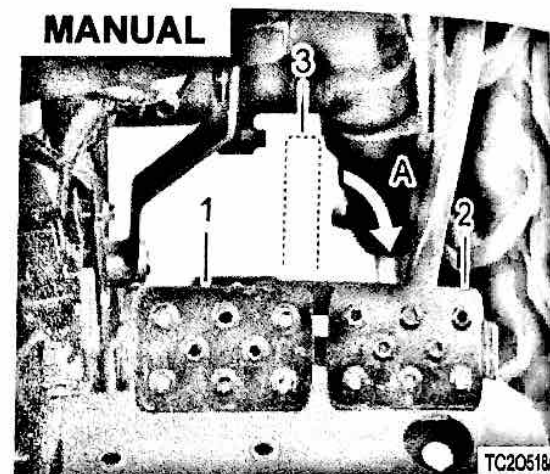

TC2O518A

- (1) Brake pedal (LH)
- (2) Brake pedal (RH)
- (3) Pedal Interlock latch
- (A) Whenever Traveling On The Road

⚠ WARNING

- **Make sure to connect the left and right brake pedals firmly before driving on a road. If they are not interlocked, the tractor can be pulled to one side, resulting in rollover or collision.**
- **When you are driving on a road, observe all local traffic and safety regulations. Only the operator should ride on the tractor.**

LOADING INTO AND UNLOADING OUT OF THE TRUCK

⚠ WARNING

- *If the tractor is broken down during driving on a road, move it to a safe place with the flasher lights blinking. If not, it can cause a personal injury.*

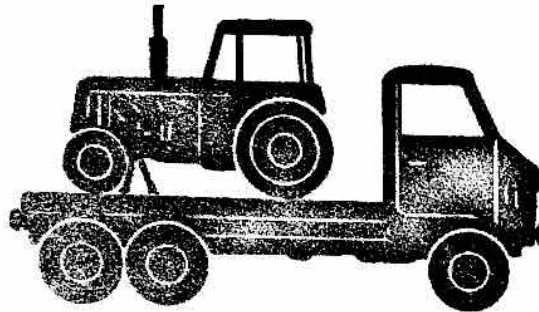

YYYO186A

⚠ WARNING

- *When transporting the tractor with a truck, fix the tractor firmly onto the truck and be aware of the height of the loaded tractor to avoid hitting the ceiling of a tunnel or the bottom of a bridge. Make sure to follow this instruction as such accidents frequently happen.*

1. When you load the tractor, load it by driving backward.
2. If the engine stalls out halfway, step on the brake pedal at once, and then release the pedal slowly to reach the road. After that, start the engine to try to load again.

PRECAUTIONS WHEN USING POWER STEERING

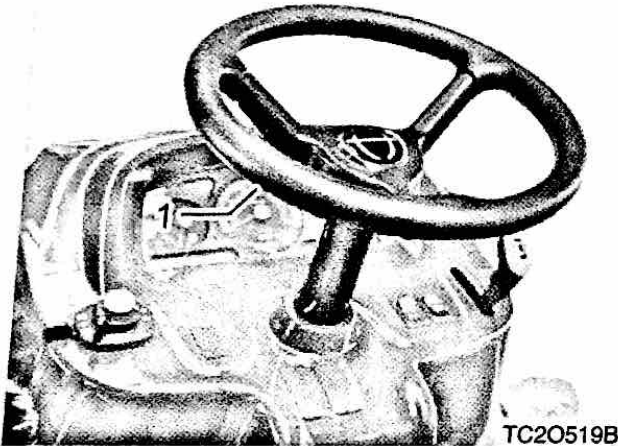

(1) Power Steering Wheel

1. The power steering function is activated only while the engine is running. The steering wheel can be operated but becomes very heavy while the engine is stopped. However, the steering wheel becomes slightly heavier when the engine is running at a low speed.

2. If you operate the steering wheel with the tractor loaded, using the implement or loader, the steering wheel operation can be somewhat a little heavy. Operate the steering wheel while driving the tractor at a low speed in this case.
3. When a loader is mounted, adjust the air pressure of the front tires to its maximum specification, mount a weight or implement on the 3 point hitch of the tractor, and remove the front weight to make the front and rear balance more stable for safe working.
4. When turning the steering wheel to its end, the operating sound of the safety valve (relief valve) can be heard. Do not operate the tractor if the valve sound is heard continually. (OK for a short period of time). The temperature of the hydraulic fluid may rise, causing malfunctions.

NOTE

The power steering system in this tractor is a load reaction, full hydraulic type.

- The full hydraulic system means that power necessary for power steering is transferred by hydraulic fluid only and therefore mechanical devices, such as racks and pinions, are not installed to the tractor. Therefore, it features simpler structure. However, the angles of the steering wheel and front wheels are not bound to each other, so they can be different sometimes. Therefore, the angle of the **KIOTI** emblem on the center of the steering wheel may differ occasionally, which is normal.

 NOTE

The power steering system in this tractor is a load reaction, full hydraulic type.

- The load reaction type means that the reaction force or impact applied to the front axle is transferred to the steering wheel. Therefore, the steering wheel can be returned to its straight-forward position from the turning position.

Therefore, it is easy to control the steering wheel during driving. (It has automatic return function, but its reactivity is not sensitive.)

 WARNING

- *When driving on a road with an implement attached to the rear of the tractor, the contact of the front wheels becomes poor, resulting in poor steerability. In this case, attach a proper front weight and drive at a low speed.*

 WARNING

- *If a malfunction occurs while driving on a road, stop the tractor in a safe place and service it. If it is not possible to move the tractor, turn on the hazard lights and set a warning triangle behind the tractor. Otherwise, a rear end accident may occur.*
- *The center of gravity of the tractor is higher compared to other common vehicles, so the possibility of the roll-over accident is very high. Be extra careful when driving on a lateral slope, bumpy road, road with puddles, and narrow road. Make sure to set the ROPS in its original position (straight up position) and fasten the seat belt.*

 WARNING

- *If stopping the engine while driving, the steering performance can become deteriorated due to loss of hydraulic power, resulting in a severe accident. Never stop the engine while driving.*
- *Keep your hands on the steering wheel after turning to return the steering wheel back to the straight-ahead position. This steering wheel is not a self-return type. Taking your hands off the steering wheel during driving can lead to a serious accident.*

3-POINT HITCH CONTROL POSITION CONTROL

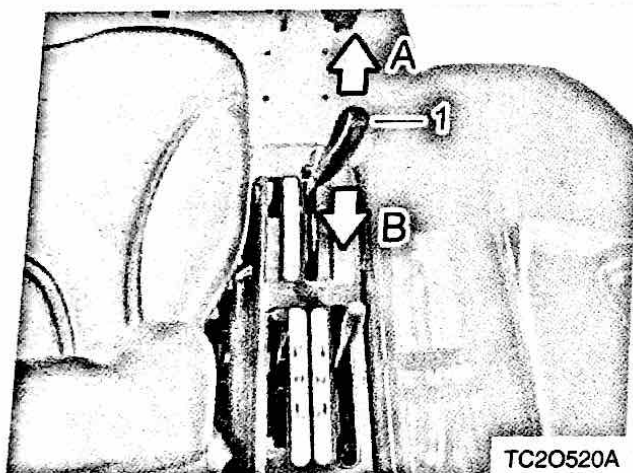

(1) Position Control Lever
(A) Lowering (B) Lifting

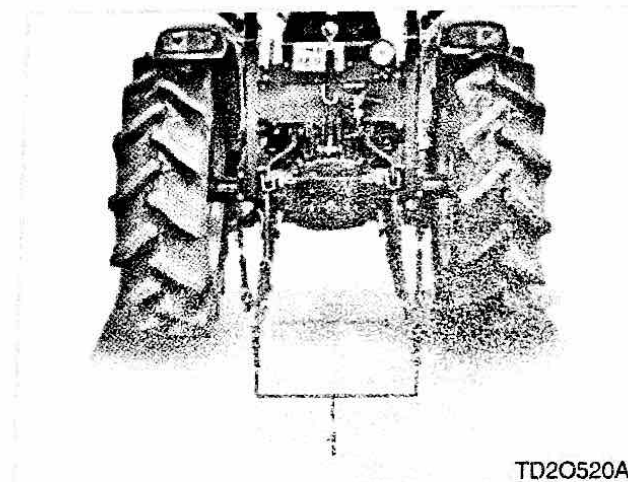

(1) Lower Link

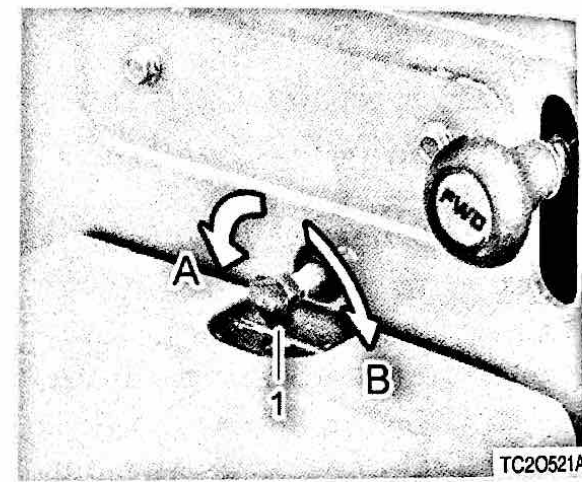

(1) Lowering Speed Control Lever
(A) High speed (B) Low speed

The 3-point hitch can be controlled by the position control lever.

1. The position control lever is used to lift or lower the lifting arm (lower link) of the 3-point hitch.
2. Pushing the lever forward lowers the lower link while pulling the lever backward lifts the lower link.
3. The height of the lower link is precisely controlled proportional to the position of the lever.

4. The lower link is lifted by the hydraulic energy of the tractor while it is lowered by potential energy of its own weight. Therefore, the implement cannot be lowered by the hydraulic pressure.

5. Therefore, the implement attached to the lower link may be lifted by protrusion on the ground when it is lowered to the ground. It is called as "floating."

6. The lowering speed of the lower link is proportional to the applied weight but can be controlled by adjusting the draining passage of the hydraulic fluid. (See "Lowering speed control valve of lifting arm" on Page 4-30)

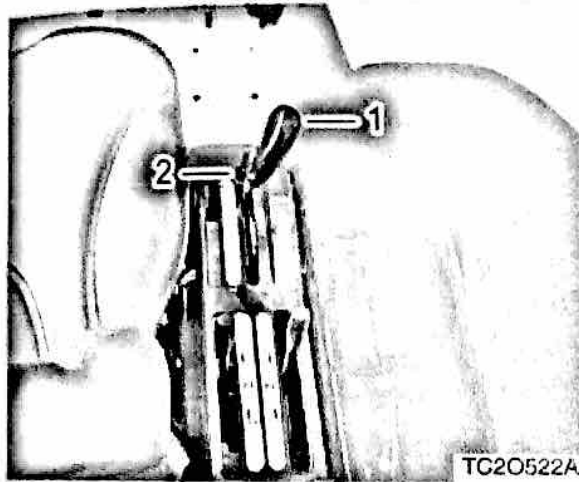

TC20522A

(1) Position Control Lever (2) Lock Bolt

7. The lower limit of the implement's height can be set by limiting the movement of the control lever by the lock bolt.

⚠ WARNING

- *If trying to lift an object with excessive weight by the 3-point hitch while the tractor is not equipped with proper front suit case weights, the front wheels may be lifted instead, leading to roll over. Make sure to follow the specifications for use.*

⚠ CAUTION

- **If the lifting arm is properly operated but abnormal noise is still heard, the hydraulic system may be malfunctioning. In this case, let the engine idle for an 10 to 15 minutes additionally and then try to start the engine again. If the problem is still present, contact your local KIOTI Dealer.**
- **If the tractor has been stored for a long period of time or the transmission fluid is just changed, abnormal noise may be heard and the hydraulic lifting arm may be inoperable temporarily. In this case, let the engine idle for 3 to 4 minutes.**

REMOTE HYDRAULICS DOUBLE ACTING LEVER (IF EQUIPPED)

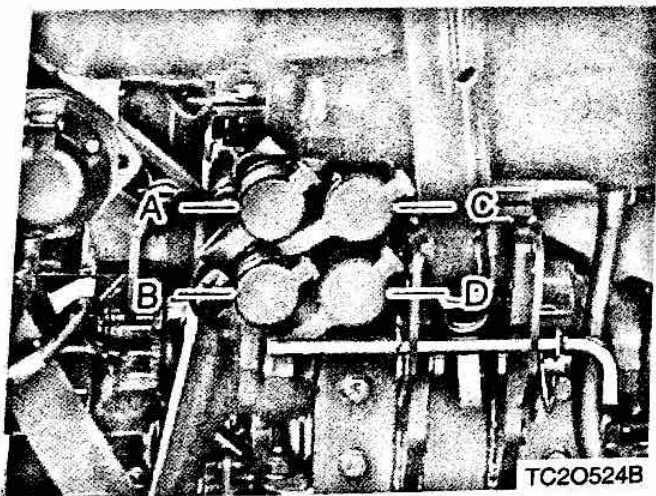
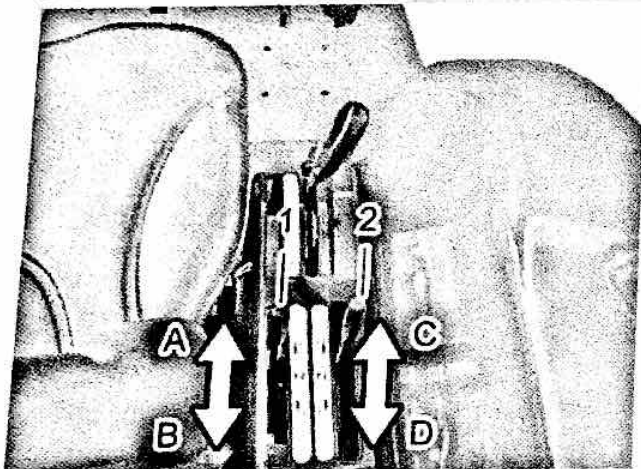

(1) Double acting valve 1, lever 1
 (2) Double acting valve 2, lever 2
 (A) Port A (C) Port C
 (B) Port B (D) Port D

Pressure → Returning ←

Lever 1		Push		Pull	
Valve 1	A	Out →		In ←	
Port	B	In ←		Out →	
Lever 2		Push		Pull	
Valve 2	C	Out →		In ←	
Port	D	In ←		Out →	

Coupler Size	
Port A, B, C, D	PT 1 / 2

This product is equipped with two double acting valves (self-return type) to supply hydraulic power to the outside. Use them properly according to an implement's specifications.

- For the self-return type double acting lever, it returns to its neutral position to block the hydraulic fluid when it is pushed/pulled and then released. Therefore, this type of double acting valve lever should be

pulled or pushed continuously for operation which is suitable for an implement with a short operating time, such as a hydraulic cylinder.

⊕ IMPORTANT

- Put the detent valve operating lever into the neutral position when the hydraulic implement is not in use. If the detent valve is kept in the operating position for an extended period of time, the relief valve is kept open and the temperature of the hydraulic fluid rises, leading to damage of various hydraulic parts, such as the oil seals and O-rings.
- When the detent valve is in operation, unnecessary load is applied to the engine. Therefore, the engine power decreases significantly, and noise and vibration increase by opening of the relief valve.

⊕ IMPORTANT

- It is hard to start the engine while the detent valve is in operation. This is especially true in winter and exhaust gas increases even after the engine is started.
- The detent valve can be applied as an option.

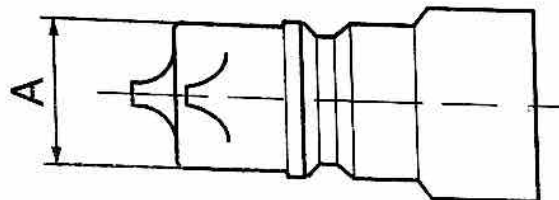
**PT1/2 COUPLER SOCKET
(IMPLEMENT)**

TC20525A

(A) Diameter

The hose unions used must comply with ISO standards.

Dimension (A) must be between 20.48 and 20.56 mm (0.806 and 0.809 in.).

CONNECTING AND DISCONNECTING IMPLEMENT CONNECTION

1. Make sure to stop the engine before connecting it.
2. Move the double acting valve lever forward and backward for 4 to 5 times to release the pressure in the hydraulic line of the tractor. Otherwise, it is hard to connect the couplers, and hydraulic fluid can be sprayed from the line and get in to your eyes while connecting them.
3. Remove any foreign material around the male and female couplers. If foreign material enters the hydraulic components, it can lead to malfunction of the system.
4. Open the dust-proof cover of the female coupler of the tractor and insert the male coupler of the implement. A clicking sound is heard when the couplers are engaged.

5. Pull the hydraulic hose of the implement to check that the couplers are properly connected.
6. Start the engine and check the operating status and leakage.

DISCONNECTION

1. Make sure to stop the engine before disconnecting it.
2. Release any residual pressure in the hydraulic hoses of the implement and tractor by operating the double acting valve lever 4 to 5 times.
3. Remove any foreign material around the couplers.
4. Lower the implement on the ground or remove any external load applied to the implement. Disconnecting hoses while outer load is applied to the implement is very difficult and dangerous due to the pressurized fluid in the hose.

5. Remove the male coupler by pushing the female coupler boss backward.
6. Close the dust-proof cover of the female coupler. Wrap the male coupler of the implement with a plastic bag to prevent contamination.

WARNING

- ***Never connect or disconnect the implement hydraulic hoses while the pressure in it is not released or the engine is running. It is hard to connect and disconnect the hose and hydraulic fluid can be sprayed from the hose, and get into your eyes or skin.***
- ***Stop the engine and wear protective glasses and gloves before work.***

3-POINT HITCH IMPLEMENT AND LOADER OPERATION

**REMOVAL AND INSTALLATION OF 3-POINT HITCH
IMPLEMENT (INCLUDING CONNECTION OF
UNIVERSAL JOINT) 6-2**

**OPERATION FOR 3-POINT HITCH IMPLEMENT
MOUNTING COMPONENTS 6-4**

ADJUSTMENT OF LIFT ROD 6-4

ADJUSTMENT OF TOP LINK 6-5

ADJUSTMENT OF CHECK LINK 6-5

DISMOUNTING THE IMPLEMENT 6-5

HITCH (OPTIONAL) AND TRAILER 6-6

INSTALLING PTO SHAFT 6-7

HANDLING LOADER 6-9

FIXATION POINTS FOR FRONT END LOADER 6-10

DRIVING ON SLOPE 6-11

HYDRAULIC BLOCK 6-12

REMOVAL AND INSTALLATION OF 3-POINT HITCH IMPLEMENT (INCLUDING CONNECTION OF UNIVERSAL JOINT)

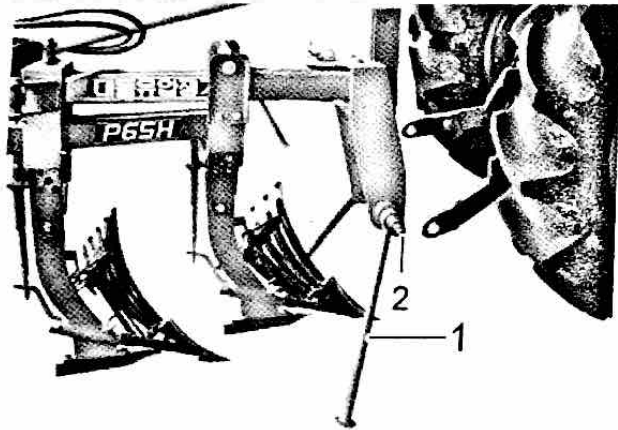

H610608B

(1) Implement support (2) Implement pin

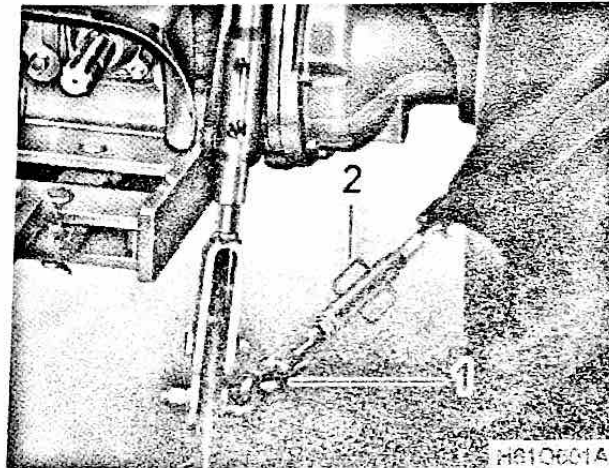

H610601A

(1) Check link (2) Turn buckle

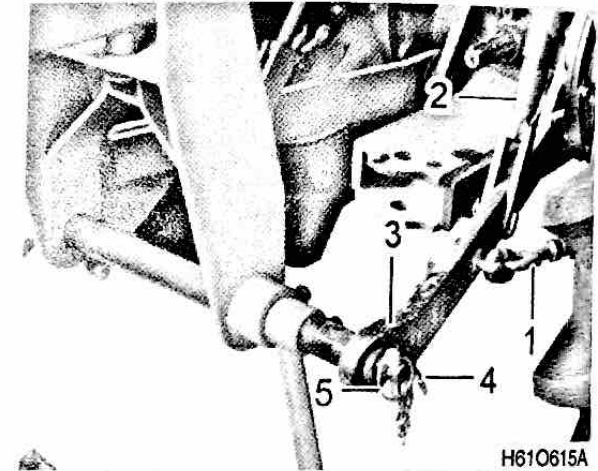

H610615A

(1) Turn buckle (2) Lift rod (RH)
(3) Lower link (4) Implement pin
(5) Lynch pin

1. Place implement on the level ground.
2. Drive the tractor backward to move as close as possible to an implement (approx. 5 cm). Then, adjust the height of the lower link to be parallel to the pins of the implement.
3. Place the shift levers in the neutral position, stop the engine and apply the parking brake.

4. Lengthen the chain by turning the check link turn buckle.

5. First install the left lower link to the implement pin, insert the lynch pin into the hole, and turn the ring to hold the implement pin securely.
6. Install the right lower link to the implement pin, insert the lynch pin into the hole, and turn the ring to hold the implement pin securely.

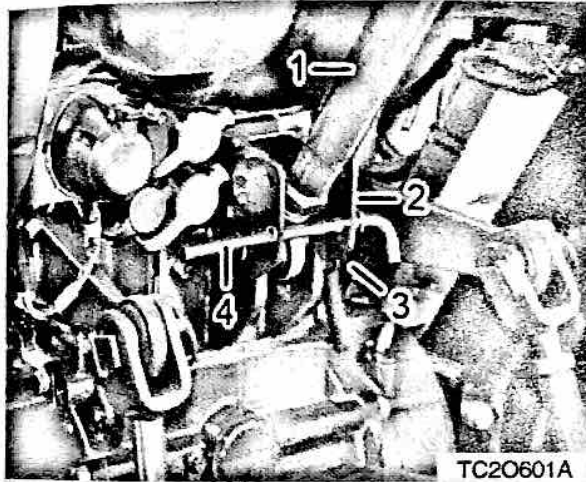

TC20601A

- (1) Top link
 (2) Top link bracket
 (3) Snap pin
 (4) Top link handle

7. Install the top link to the top link hole of the implement. Loosen the lock nuts of the top link and turn the top link handle to adjust the length of it as needed. Align the pin hole for the top link with the top link hole on the implement to insert the set pin. Insert the snap pin into the set pin hole securely to hold the set pin.

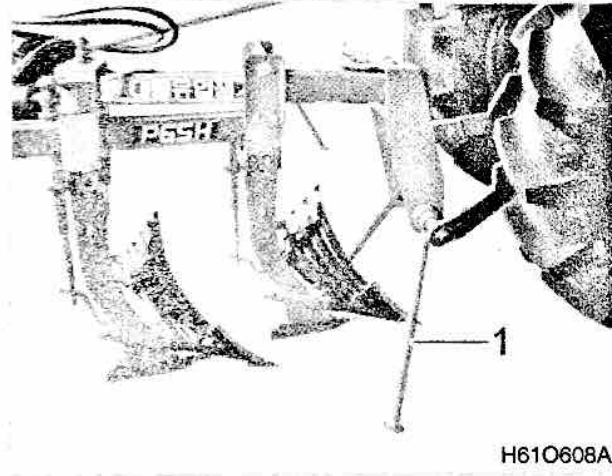

H610608A

- (1) Implement Support

8. Raise up the implement with the position control lever of the tractor. Remove the implement support as needed. Align the implement by adjusting the length of the check chains on both sides. Tighten the lock nuts on the check chain securely.
9. Adjust the tip angle of implement by adjusting the length of the top link. Tighten the top link lock nuts securely.

10. Adjust the balance of the implement by adjusting the length of the lift rod (RH). Tighten the turn buckle lock nut of the lift rod (RH) securely afterward.

OPERATION FOR 3-POINT HITCH IMPLEMENT MOUNTING COMPONENTS

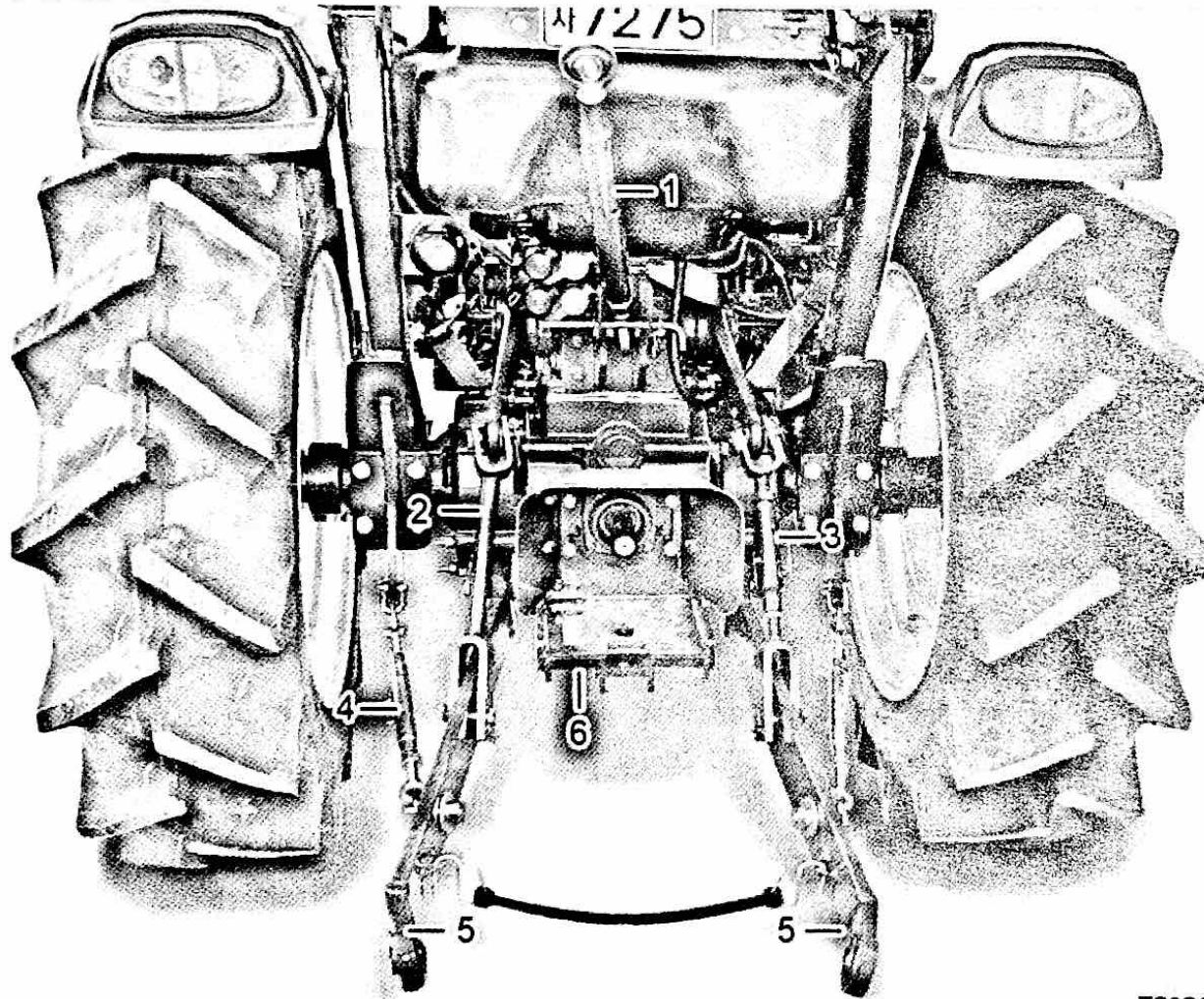

(1) Top link
(2) Lift Rod (L)

(3) Lift Rod (R)
(4) Check Chain

(5) Lower link
(6) Hitch (optional)

TC20602A

ADJUSTMENT OF LIFT ROD

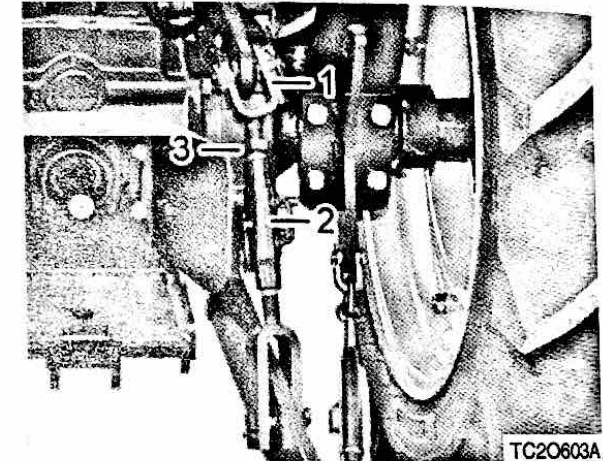

TC20603A

(1) Lift rod
(3) Lock Nut

(2) Turn buckle

1. Adjust the implement balance by turning the turn buckle.
2. After adjustment, secure it with the lock nut.

ADJUSTMENT OF TOP LINK

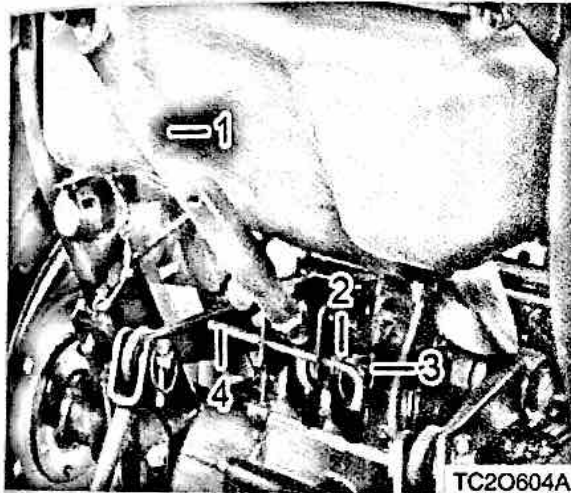

- (1) Top link
 (2) Set pin
 (3) Lynch pin
 (4) Top link handle

1. Install the top link to the desired hole, install the set pin and lynch pin securely.
2. Tighten the lock nut on the top link securely after adjusting top link length.

ADJUSTMENT OF CHECK LINK

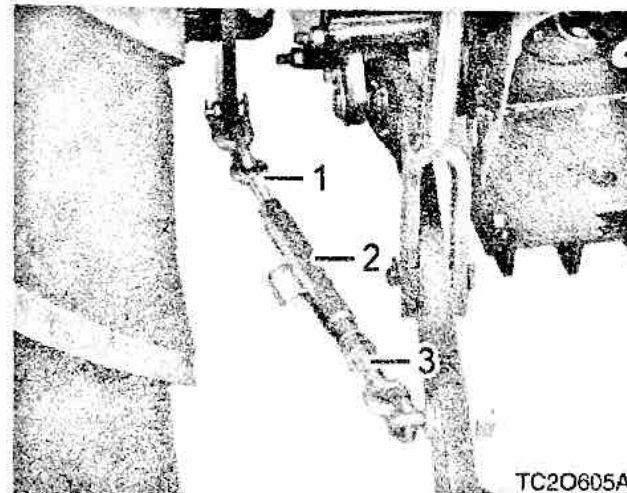

- (1) Check chain
 (2) Turn buckle
 (3) Lock Nut

1. Adjust the check chain to control horizontal sway of the implement. It is also used to set the implement on the back of the tractor in center.
2. Loosen the lock nut To adjust the check chain, pull out the turn buckle and adjust it until the desired transverse moving distance is obtained.

DISMOUNTING THE IMPLEMENT

1. Park the tractor with the implement on the level ground and lower the implement all the way down. Install the implement support as needed.
2. Disconnect the top link and lower links from the implement by removing the pins.
3. Be sure to insert the set pins, lynch pins and snap pins back to the implement securely to keep those safe.
4. Stop the engine and move the remote hydraulic control lever back and forth to release the hydraulic pressure in the system before disconnecting hydraulic couplers.
5. Put the top link back to its hook. Hold both lower links together with a rubber band. Otherwise, the lower links can contact with rear tires and cause damage to the lower links and tires while driving.

HITCH (OPTIONAL) AND TRAILER

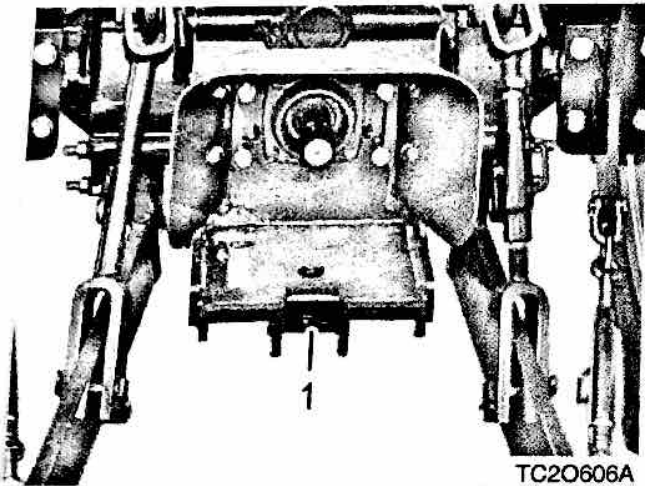

(1) Hitch

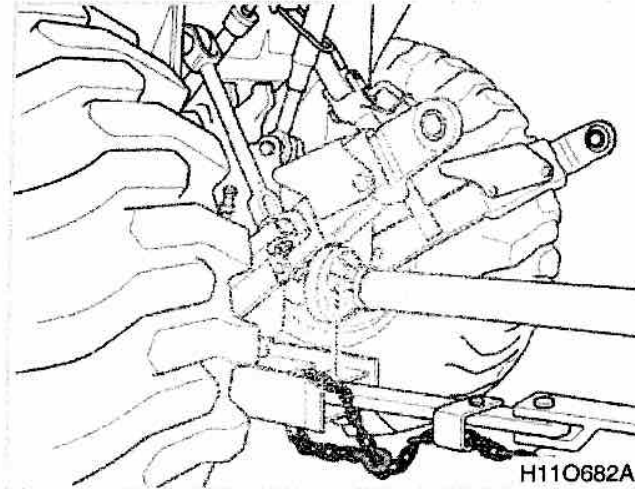

(1) Safety Chain

The hitch is used to pull an implement, such as a trailer.

Make sure to check the max. towing weight of the trailer and max. vertical load that can be applied to the draw bar.

Max. trailer weight (trailer + loaded weight)	3,000 kg (6,613 lbs)
Vertical load on the draw bar	650 kg (1,433 lbs)

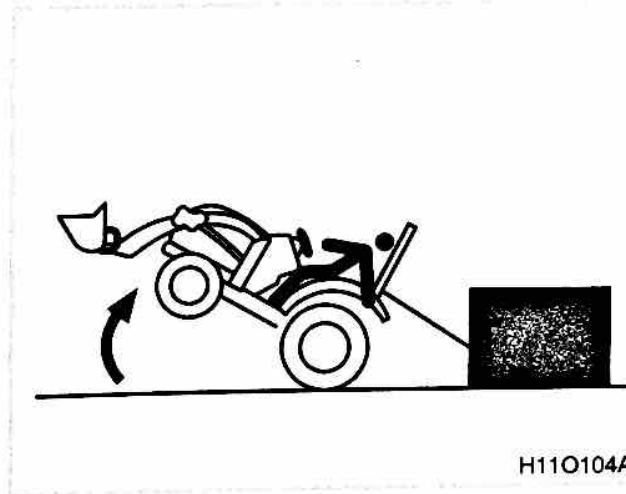

⚠ WARNING

- *Never use any other part for pulling except draw bar. Pulling with top link, ROPS and etc. will cause a fatal accident.*
- *Be sure to install the auxiliary safety chain when installing a trailer.*
- *Improper use of the draw-bar, even if correctly positioned, can cause a rear overturn.*
- *Do not overload an implement or towed equipment. Use proper counterweights to maintain tractor stability. Hitch heavy loads to the draw-bar only.*
- *Make sure that there is no one nor object between the tractor and trailer.*

INSTALLING PTO SHAFT

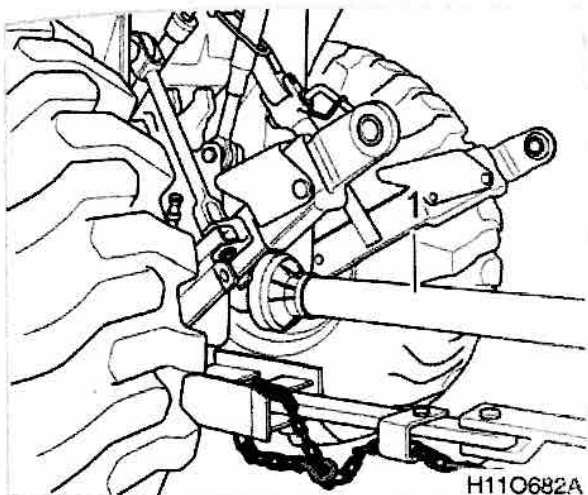

(1) Universal Joint

1. Consult your local **KIOTI** Dealer for selection of the universal joint.
2. When selecting a universal joint, make sure that it is not too short to come off of the female and male shafts at the highest position or too long to impact its female and male shafts at the lowest position.
3. Move the joint back and forth to check that its lock pin is properly seated to the groove of the PTO shaft.

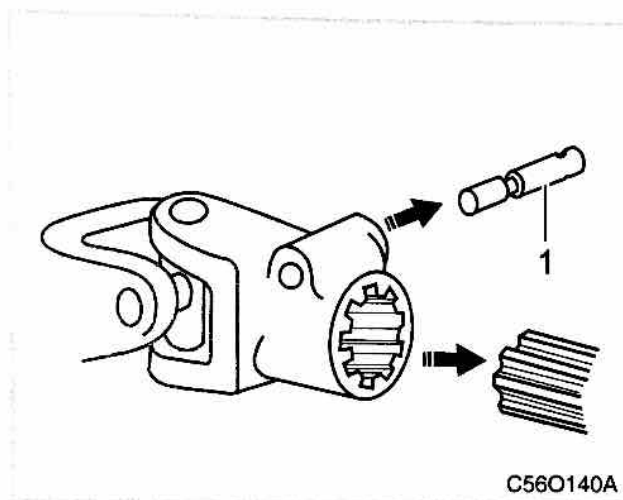

(1) Lock Pin

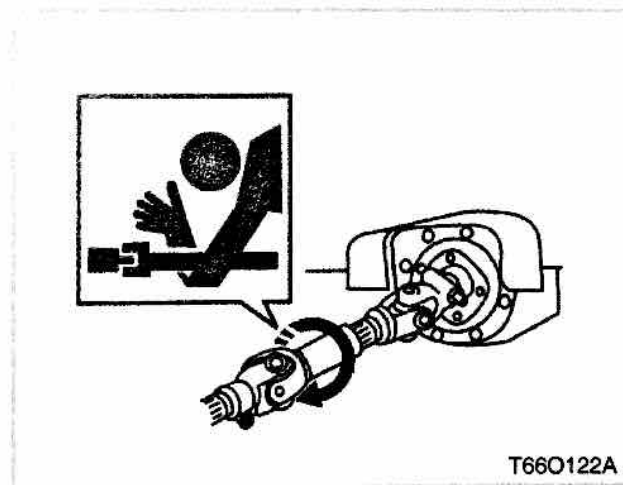

⚠ WARNING

- **Make sure that the PTO safety cover is in its position before driving the PTO shaft.**
- **Never go close to the rotating PTO or universal joint shaft. A severe accident can happen.**
- **Before driving an implement through the PTO, always make sure that all bystanders are well away from the tractor.**
- **When using the PTO drive with a stationary tractor, always make sure that the gears are in neutral and that the parking brake is applied.**
- **The tractor PTO and universal joint should not be interfered by any surrounding parts.**

⚠ WARNING

- *Before starting up any PTO-driven implement hitched to the three-point linkage, lift the implement to its full height and check that at least 1/4 of the total length of the telescopic section of the drive shaft is engaged.*

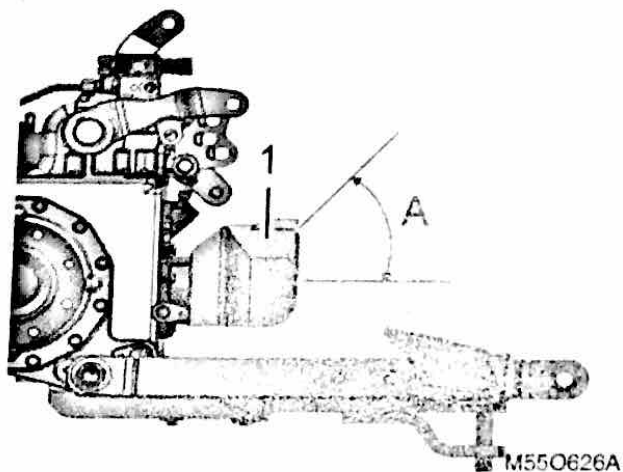

(1) PTO Cover

(A) Allowable angle of universal joint: 50°

Refer to the chart below as to installing of an universal joint.

TYPE OF PTO SHAFT

SAE 1-3 / 8" 6 splines

Allowable angle of universal joint

50°

HANDLING LOADER

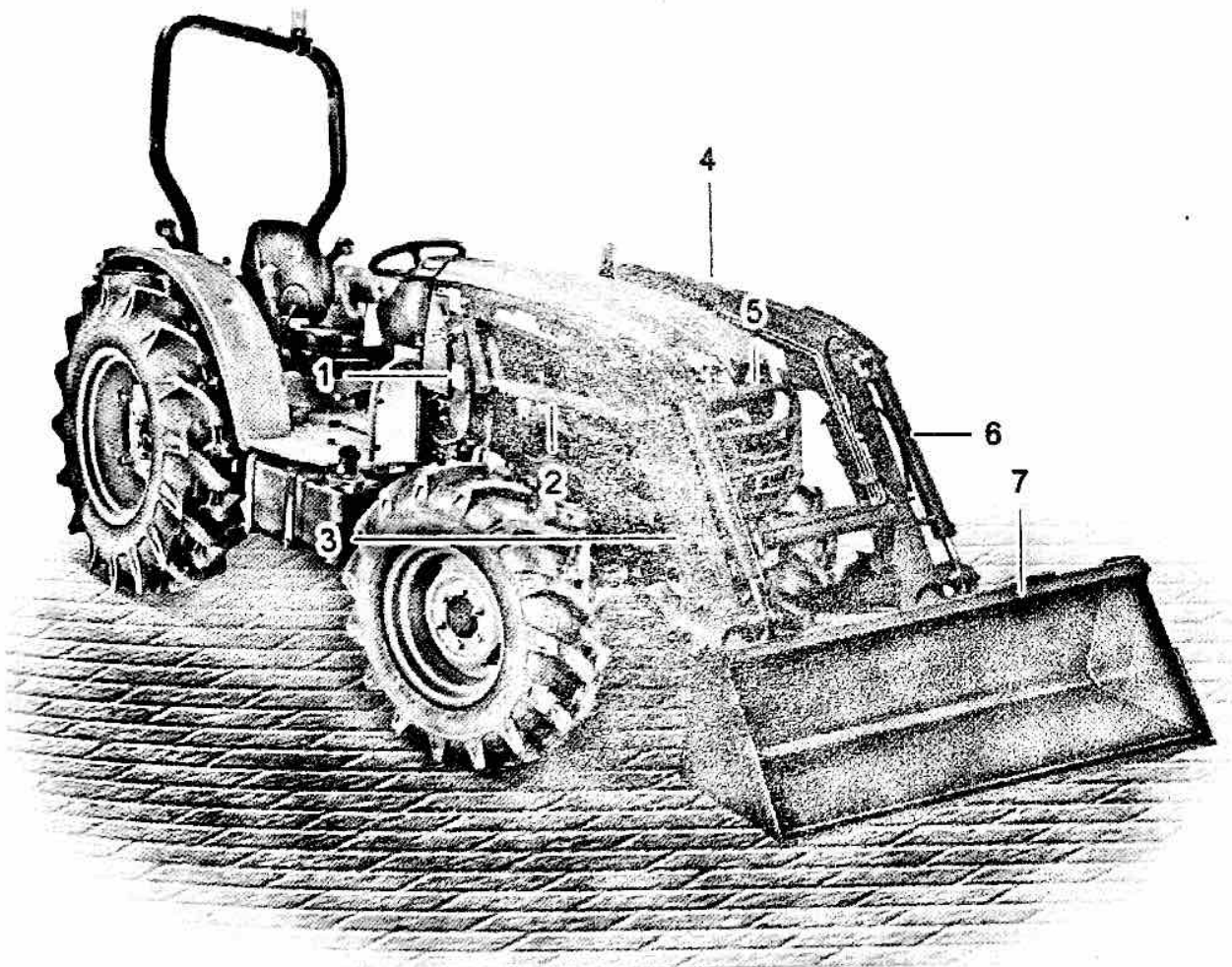

- (1) Loader Mounting Bracket
- (2) Balancing Cylinder
- (3) Loader Arm
- (4) Boom
- (5) Grill Guard
- (6) Tilt Cylinder
- (7) Bucket

For detailed information about installation and use of the front loader, refer to the separate manual of the loader.

+ IMPORTANT

- Check the transmission fluid level and add fluid as necessary after installing an implement related to the hydraulic fluid, such as a loader or backhoe, and driving the tractor for a test.

TD20631A

FIXATION POINTS FOR FRONT END LOADER

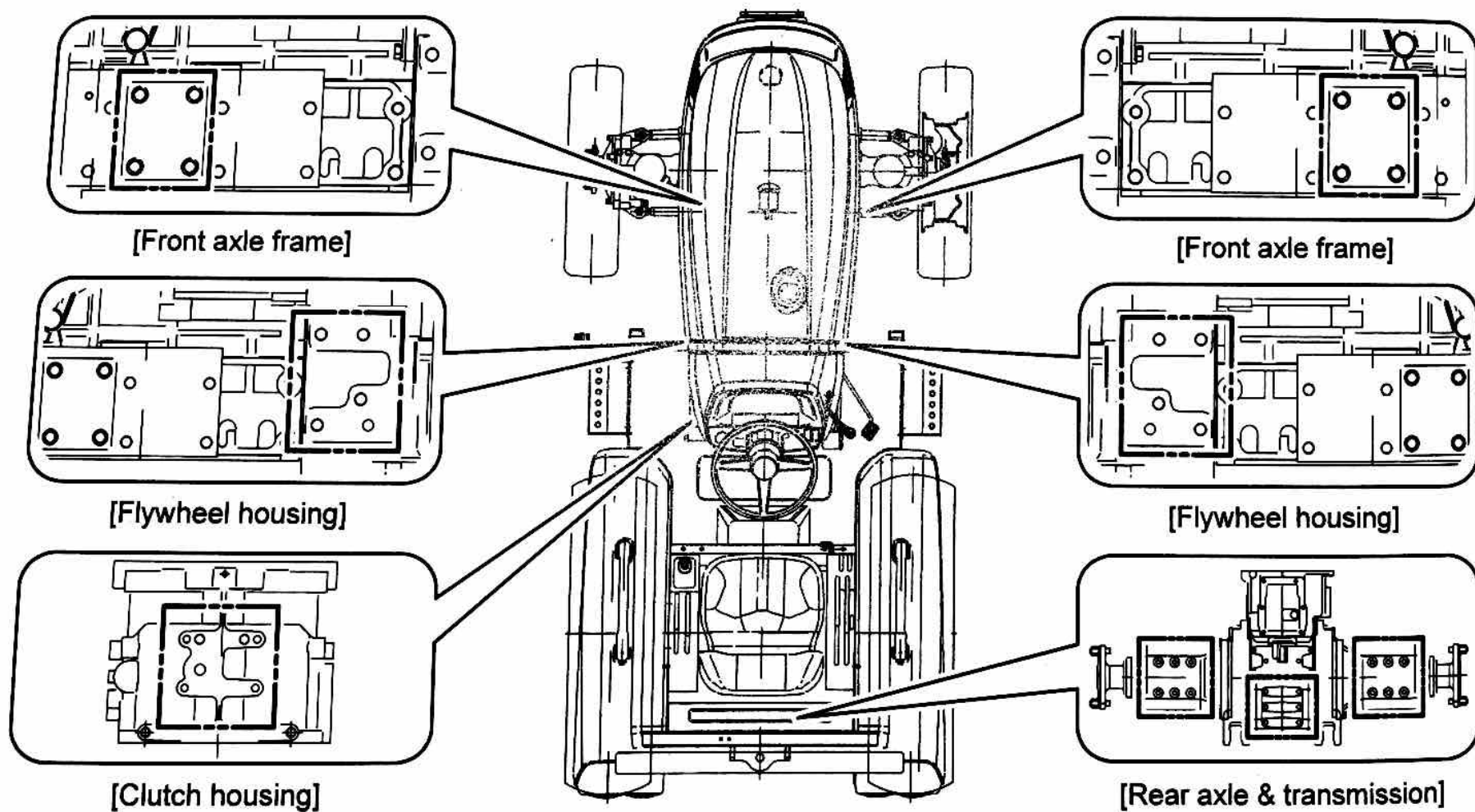

S760605A

▲ WARNING

- **When you do install the front loader, certainly mount the bolt for mounting bracket at the indicated points.**

DRIVING ON SLOPE WHEN LOADED BUCKET AND REAR BALLAST ARE INSTALLED

Driving on uphill

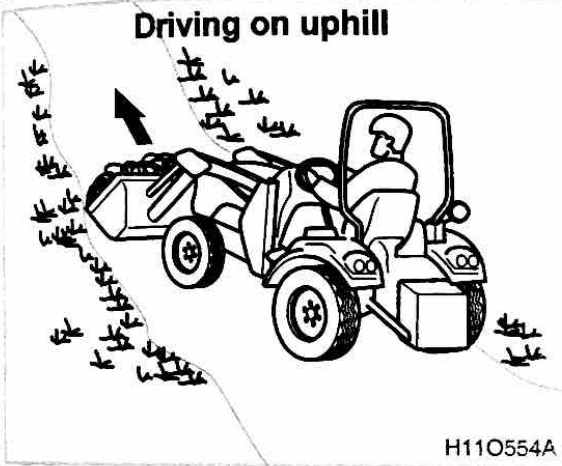

H11O554A

WHEN UNLOADED BUCKET AND REAR BALLAST ARE INSTALLED

Driving on uphill



H11O556A

When driving downhill with the empty bucket and rear ballast installed, keep the rear ballast toward the higher level of the ground. In other words, drive backward on uphill and forward on downhill.

Use the 4WD to increase traction when driving on a slope with the loaded bucket and rear ballast installed.

On a bumpy road, lift the bucket and implement high so that they do not hit any obstacle.

Driving on downhill

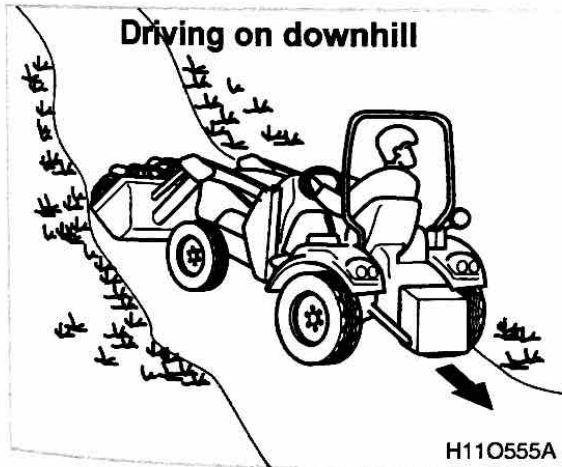

H11O555A

Driving on downhill



H11O557A

PARKING WITH LOADER INSTALLED

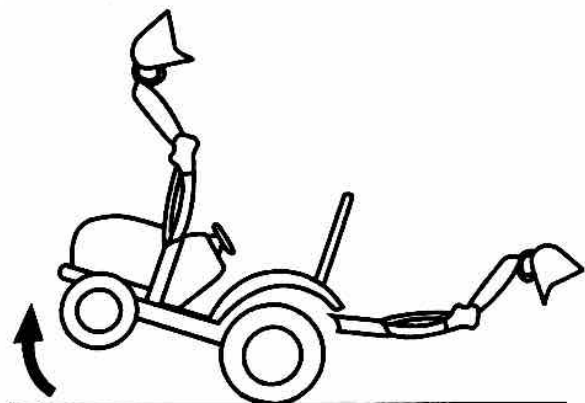

M55O625A

HYDRAULIC BLOCK

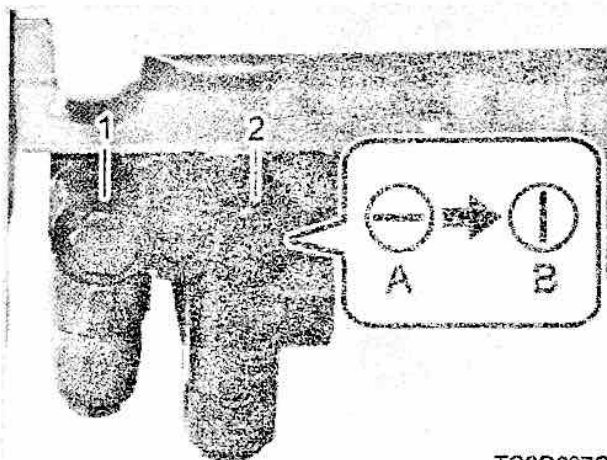

TC2O607C

- (1) In (From implement's control valve)
 (2) Out (To implement's control valve)
 (A) OFF (B) ON

⚠ CAUTION

- When parking the tractor which is equipped with a loader or backhoe, make sure that the boom of the loader or backhoe is lowered on the ground. Otherwise, the tractor can become unstable, leading to an unexpected accident, such as roll over.

📖 NOTE

- The hoses and couplers for installation are supplied with the loader.
- For details about the implement installation method, refer to KIO-TI front loader owner's manual.

⚠ WARNING

- **Never let anyone get in the loader and use the loader as a workbench. Otherwise, it may lead to an injury or even death.**
- **Do not stand under the lifted loader or get close to it. Also, lower the loader arm onto the ground before leaving the tractor. Otherwise, it may lead to an injury or even death.**
- **Never carry a big object with the loader unless a proper implement is attached. Keep a carried object low during driving. Otherwise, it may lead to an injury or even death.**

⚠ WARNING

- *When attaching or detaching the loader, fix all parts which are connected to the bucket and boom. The bucket or boom can be accidentally dropped down, leading to an injury or even death.*
- *Do not allow loader arms or implement to contact electrical power lines. Electrocutation will cause a serious injury or death.*

⊕ IMPORTANT

- **ROPS (Roll Over Protective Structure), sun canopy or cabin are not a FOPS (Falling Object Protective Structure). It never can protect the riders against falling objects. Avoid driving the vehicle into a dangerous area such as falling rocks zone. Otherwise, it may lead to a serious injury.**

MAINTENANCE

7

MAINTENANCE CHECK LIST 7-3

DAILY CHECK ITEM 7-3

MAINTENANCE SCHEDULE CHART 7-4

LUBRICANTS 7-8

MAINTENANCE CODE 7-9

HOW TO DISCONNECT THE HOOD (A)..... 7-9

CHECKING AND ADDING FUEL (C) 7-9

CHECKING TRANSMISSION FLUID
LEVEL (D)..... 7-10

CHECKING ENGINE OIL LEVEL (E) 7-11

CHECKING COOLANT LEVEL (F)..... 7-12

CLEANING RADIATOR GRILL AND
SCREEN (G)..... 7-13

CHECKING BRAKE AND CLUTCH
PEDALS (H)..... 7-14

CHECKING GAUGES, METER AND
INDICATORS (I) 7-14

CHECKING HEAD LIGHT, HAZARD
LIGHT ETC. (J)..... 7-14

CHECKING SEAT BELT AND ROPS (K).... 7-14

CHANGING ENGINE OIL AND
REPLACING FILTER (L) 7-14

REPLACING TRANSMISSION FLUID
AND FILTER (M)..... 7-17

CHANGING FRONT AXLE CASE OIL (N).. 7-18

ADJUSTING BRAKE PEDAL (O) 7-19

LUBRICATING GREASE NIPPLE (P) 7-21

CHECKING WHEEL BOLT/NUT TORQUE (Q).. 7-22

ADJUSTING CLUTCH PEDAL (R) 7-22

FUEL FILTER (S)..... 7-23

CLEANING AND REPLACING AIR
CLEANER FILTER (T) 7-23

CHECKING FUEL LINES (U) 7-24

ADJUSTING FAN BELT TENSION (V) 7-25

BATTERY (W)..... 7-26

CHECKING INTAKE AIR LINE (X) 7-28

ADJUSTING TOE-IN (Y) 7-28

MAINTENANCE

CHECKING RADIATOR HOSE AND CLAMP (Z).....	7-29
POWER STEERING LINE (AA).....	7-29
ADJUSTING FRONT AXLE PIVOT PIN (AD)	7-30
ADJUSTING ENGINE VALVE CLEARANCE (AE).....	7-30
REPLACING AIR CLEANER FILTER (AF) ..	7-30
FLUSH COOLING SYSTEM AND CHANGING COOLANT (AJ)	7-31
ANTI-FREEZE	7-33
BLEEDING FUEL SYSTEM (AK)	7-34
DRAINING WATER FROM CLUTCH HOUSING (AL)	7-35
BODY FUSE (AN).....	7-35
MAIN FUSE (AP).....	7-37
REPLACING BULB (AQ).....	7-38

MAINTENANCE CHECK LIST

DAILY CHECK ITEM

SERVICE SCHEDULE		Maintenance codes
Item	SERVICE REQUIRED	
Engine Oil	Check the oil level and add as needed. Do not overfill.	E
Hydraulic (Transmission/ front axle) oil level	Check level and add as needed.	D
Air cleaner and its filter	Check the filter condition for leakage and damage. Clean the element.	T
Engine Cooling System	Clean the radiator, screen and grill. Check coolant level and add anti-freeze if necessary.	F, G, AC
Seat Belt	Check the condition of seat belt and mounting hardware. Repair or replace as needed.	
Tires	Check for wear, damaged tires and ensure for proper sized tires and correct air pressure.	
Parking brake	Check for automatic rotation and have it adjusted by your dealer if necessary.	
Clean Pedals	Clean brake pedals, travel control pedal, clutch pedal and footrest area.	H
General Items	Check for loose or broken parts, damaged cabin component, instrument operation, loose wheel nuts / bolts, oil leaks and damaged or missing signs (Decals), floor mat. Replace them as necessary.	Q, AG, AH, AM
PTO	Check spline condition. Replace the PTO cover if damaged or missing.	
Three-point Linkage	Check operation and condition of pins, links and bars.	
Loader (If Equipped)	Check mounting hardware for loose or broken parts.	

* Refer to section "Maintenance code" for detailed information related to maintenance codes.

MAINTENANCE SCHEDULE CHART

NO.	Item	Maintenance Interval		Run Hour										Run Age		Remarks	Maintenance codes		
				10	50	100	200	250	400	600	800	1500	3000	1 Year	2 Year				
1	Engine oil & Filter	Change	DI / IDI		⊙			○							○			L	
			CRDI	Tier2 or 3				○								○			
				Tier4						○							○		
		Check			○														E
2	Transmission oil filter	Replace		⊙		○												M	
3	HST oil filter	Replace		⊙		○													
4	Transmission fluid	Change						○										M	
	Transmission fluid level	Check	⊙															D	
5	Front axle oil	Change						○										N	
	Front axle oil level	Check	⊙																
6	Front axle pivot	Adjust								○									
7	Engine start system	Check		○															
8	Greasing	Apply		○														P	
9	Wheel bolt torque	Check		○														Q	
10	Battery condition	Check			○												*3	W	

※ Tier2 or 3 - Without DPF, Tier4 - With DPF
 ※ DI: Direct Injection / IDI: In Direct Injection / CRDI: Common Rail Direct Injection

NO.	Item	Maintenance Interval	Run Hour										Run Age		Remarks	Maintenance codes		
			10	50	100	200	250	400	600	800	1500	3000	1 Year	2 Year				
11	Air cleaner element	Check	⊙															T, AF
		Clean			○										*1	#		
		Replace				○							○		*2			
12	Fuel filter element	Replace				○										#	S	
13	Fan belt, Air-con belt	Adjust			○											*3	V, AB	
14	Clutch pedal free play	Adjust		⊙	○												O	
15	Brake pedal free play	Adjust		⊙	○												R	
16	Radiator hose and clamp	Check				○												G
		Replace												○				
17	Radiator grill	Clean	⊙														Z	
18	Power steering hose and oil line	Check				○												AA
		Replace												○				
19	Fuel line	Check			○												#	U
		Replace												○				
20	Intake air line	Check				○												X
		Replace												○	*3			

NO.	Item	Maintenance Interval	Run Hour										Run Age		Remarks	Maintenance codes	
			10	50	100	200	250	400	600	800	1500	3000	1 Year	2 Year			
35	3-point hitch & drawbar	Check	<input type="radio"/>														
36	Pin fastening	Check	<input type="radio"/>														

⊕ IMPORTANT

- must be done after the first 10 or 50 hours of operation.
- * 1 Air cleaner should be cleaned more often in dusty conditions than in normal condition.
- * 2 Every year or every 6 times of cleaning. * 3 Replace only if necessary.
- The items listed above (# marked) are registered as emission related critical parts by KIOTI in U.S. EPA exhaust emission standard non-road emission regulation. As the engine owner, you are responsible for the performance of the required maintenance on the above instruction.

LUBRICANTS

To prevent serious damage to the equipment, use only genuine **KIOTI** fluids, oils and greases or equivalents.

No.	Item	[U.S.gal. (L)]	Lubricants
1	Fuel	8.98 (34.0)	Ultra-low sulfur diesel (Sulfur content: 15 ppm or less)
2	Coolant	2.72 (10.3): US 2.64 (10.0): EU/AU/TH	Antifreezing solution: Ethylene glycol + Pure water (50:50)
3	Engine oil	1.58 (6.0): US 1.45 (5.5): EU/AU/TH	Engine oil : Tier 2 or 3 - API CH grade above Tier 4 - API CJ grade above Oil Viscosity : SAE 10W30, 10W40, 15W40
4	Transmission fluid	5.81 (22.0)	DAEDONG : UTF55 or S h e l l : Donax-TD, Exxonmobil: Mobilfluid 424 Exxon Hydraul 560 B P : Tractran UTH In winter season : DURATRANTM XL Synthetic Blend
5	Front axle oil	1.58 (6.0)	SAE 90 gear oil or better, or same as Transmission oil
6	Grease - Front axle support - Brake pedal - Brake lever - Top link holder - Control lever	A little	SAE multi-purpose type grease

WARNING

- **Check the oil level periodically. Correct the oil level, if needed, before operating.**
- **Always check and add oil with the tractor on a flat, level surface.**

MAINTENANCE CODE

HOW TO DISCONNECT THE HOOD (A)

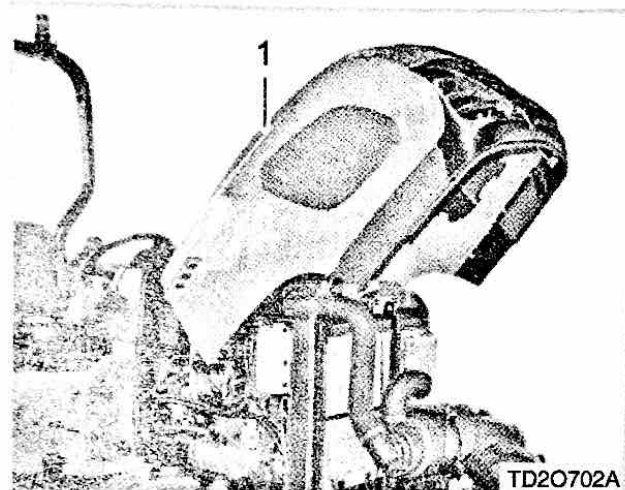
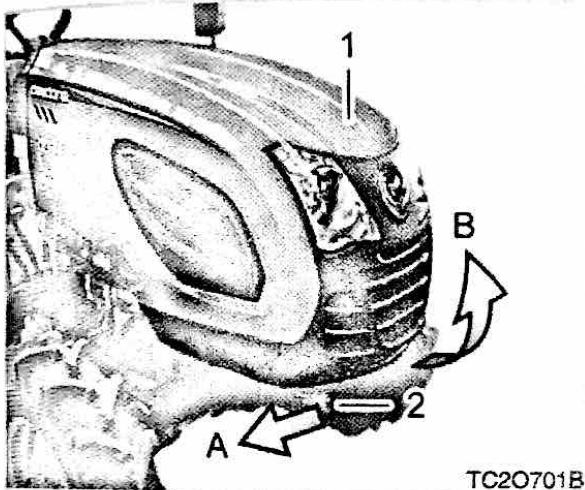

CHECKING AND ADDING FUEL (C)

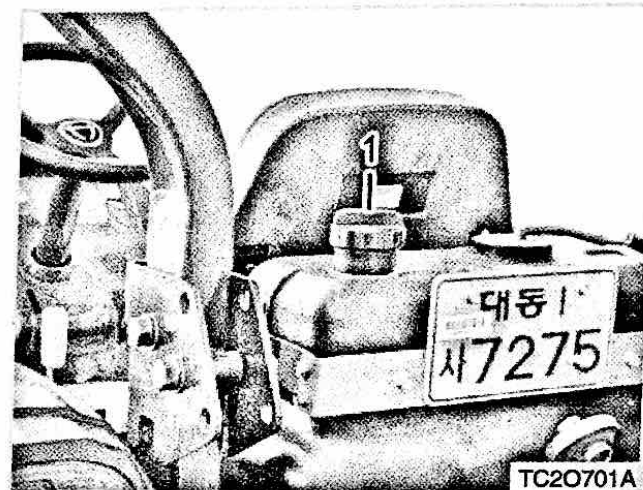

- (1) Hood
- (2) Opening knob
- (A) Pull
- (B) Open

(1) Hood

(1) Fuel Tank Cap

1. It is very easy to open the hood with one touch pulling knob.
2. The hood stays open by itself with air cylinder. To close it, just press down without any bothering process.

⚠ CAUTION

- **Never open the hood while the engine is running.**

The fuel tank is installed in the middle of the tractor body. Make sure to use pure and high-quality diesel fuel.

FUEL TANK CAPACITY
8.98 U.S.gal. (34 L)

1. Turn the key switch to "ON" and check the amount of fuel with the fuel gauge.
2. If the needle on the fuel gauge is close to "E" or the fuel level is low, open the fuel tank filler cap and add the fuel.
3. After adding the fuel, close the fuel tank filler cap.

⚠ CAUTION

To avoid personal injury:

- Do not smoke while refueling.
- Add fuel in a well-ventilated area.
- Be sure to stop the engine before refueling.
- As dirt or sand contained in fuel may cause malfunction to the fuel injection pump, use the strainer when refueling.

⊕ IMPORTANT

- Be careful not to let the fuel tank become empty. Otherwise air will enter the fuel system, necessitating bleeding before next engine start.
- Be careful not to spill during refueling. If a spill occur, wipe it off at once, or it may cause a fire.
- If unit is not used for a long time, make sure the fuel viscosity is suitable for the cold weather.

CHECKING TRANSMISSION FLUID LEVEL (D)

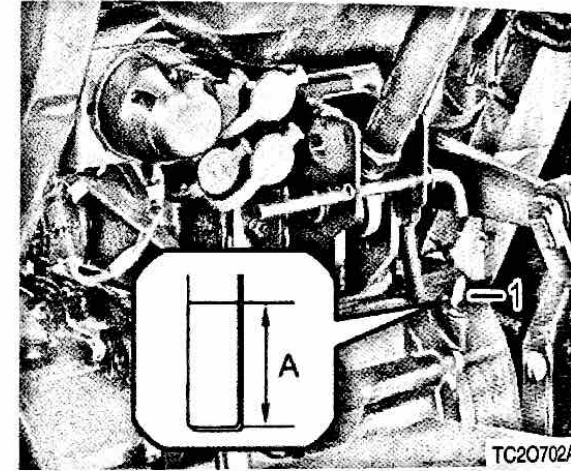

(1) Oil dipstick and filler port
(A) Oil Level is Acceptable Within This Range

1. Park the tractor on a level ground and lower the implement.
2. Make sure the parking brake is set.
3. Set all shift levers into the neutral position.
4. Stop the engine.

CHECKING ENGINE OIL LEVEL (E)

⊕ IMPORTANT

- If the level is low, do not run the engine.
- Never add oil over the upper limit.
- Be sure to check the oil level after installing a hydraulic implement.
- Add fluid as needed.
- Check the oil level with the cylinders of an implement extended and check again with the cylinders retracted. Add oil to adjust the oil level within the range of the oil limit. (Upper or lower)

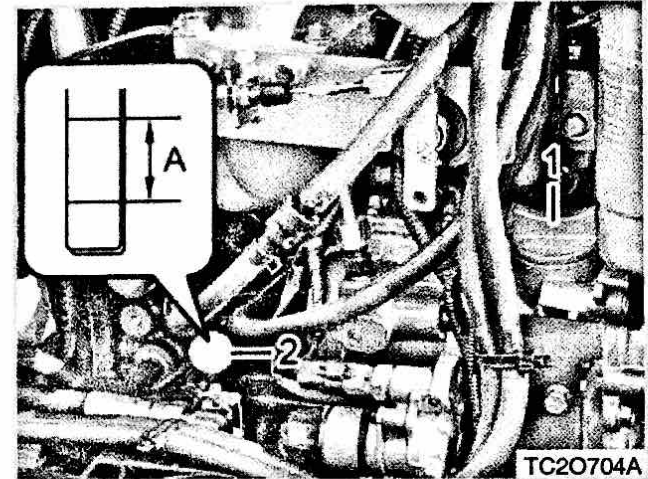

(1) Oil filler neck (2) Oil dipstick
(A) Oil Level is Acceptable Within This Range

1. Check the engine oil daily.
2. Park the tractor on a level ground and lower the implement.
3. If the engine was just running, wait for approx. 5 minutes before checking the oil level.

⚠ CAUTION

To avoid injury:

- Be sure to stop the engine before checking the oil level.

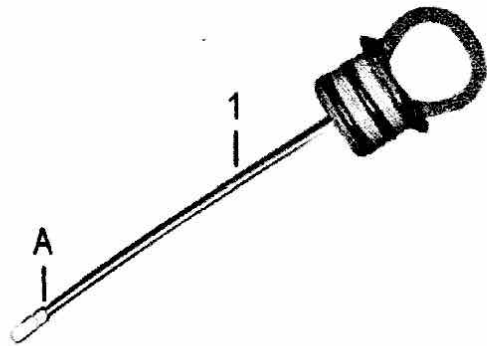

TC2O703A

(1) Oil dipstick
(A) Upper Limit

5. Pull out the oil dipstick, clean it, and then insert it into its original position. Then, pull it out again and check if the oil level is within the specified range.

6. If the oil level is too low, add some new oil so that the level is within the allowable range.

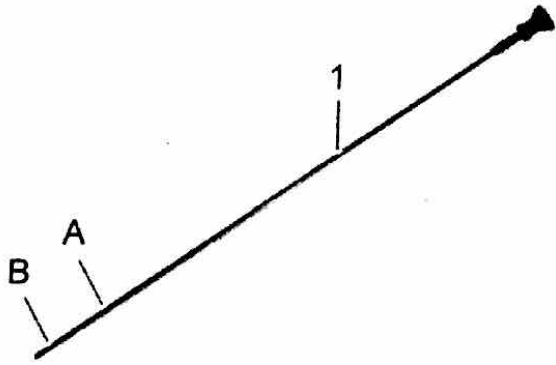

TD2O707A

(1) Oil dipstick
(A) Upper limit

(B) Lower limit

4. Pull out the oil dipstick, clean it, and then insert it into its original position. Then, pull it out again and check if the oil level is within the specified range.
5. If the oil level is too low, add some new oil so that the level is within the allowable range.

⊕ IMPORTANT

- When using oil of different maker or viscosity from the previous one, remove all of the old oil. Never mix two different types of oil.
- Do not start the engine when the oil level is below the lower limit.
- Wipe the oil dipstick with clean cloth or tissue. If foreign material enters the oil sump, it can lead to malfunction of the engine.
- Never add oil over the upper limit.

CHECKING COOLANT LEVEL (F)

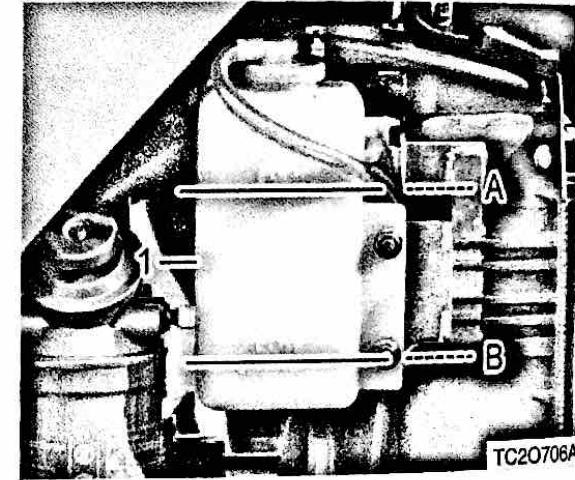

(1) Reservoir Tank
(A) FULL

(B) LOW

1. Check to see that the coolant level is between the "FULL" and "LOW" marks of the reservoir tank.
2. When the coolant level drops due to evaporation, add water only up to the "FULL" level mark. In case of leakage, add anti-freeze and water in the specified mixing ratio up to the "FULL" level mark. (Refer to the instructions for cleaning the cooling system and changing cool-

ant in Chapter Maintenance for every two years.)

3. The tractor is furnished in the factory with a mixture of anti-freeze (ethylene glycol) and water in a ratio of 50:50 which is usable in any season.

CLEANING RADIATOR GRILL AND SCREEN (G)

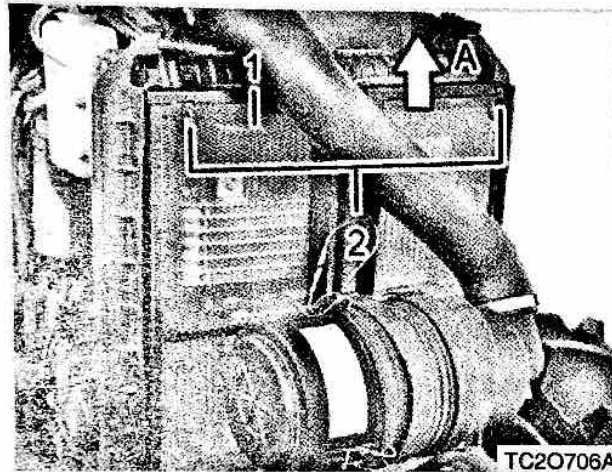

(1) Radiator screen (2) Nut
(A) Detach

1. Check that the radiator grill and screen are free of foreign materials.
2. If there are foreign materials stuck in the screen, unscrew its nut, remove it from the mounting location and remove all foreign materials from it.

CAUTION

To avoid accidents:

- Be sure to stop the engine before removing the screen.

IMPORTANT

- The bonnet grill and screen must be clean from debris to prevent the engine from overheating and to allow good air intake for the air cleaner.

CHECKING BRAKE AND CLUTCH PEDALS (H)

1. The brake and clutch pedals should be inspected for free travel, and smooth operation.
2. You should adjust these pedals if an incorrect measurement is found. (Refer to the instructions for adjusting the clutch and brake pedals in the Chapter Maintenance.)



NOTE

- When depressing the brake pedals separated, both of the brake pedals should be moved down to the same depth.

CHECKING GAUGES, METER AND INDICATORS (I)

1. Inspect the instrument panel for broken gauge(s), meter(s) and indicators.
2. Replace if broken.

CHECKING HEAD LIGHT, HAZARD LIGHT ETC. (J)

1. Inspect the lights for broken bulbs and lenses.
2. Replace if broken.

CHECKING SEAT BELT AND ROPS (K)

1. Always check the condition of the seat belt and ROPS before operating the tractor.
2. Replace if damaged.

CHANGING ENGINE OIL AND REPLACING FILTER (L)

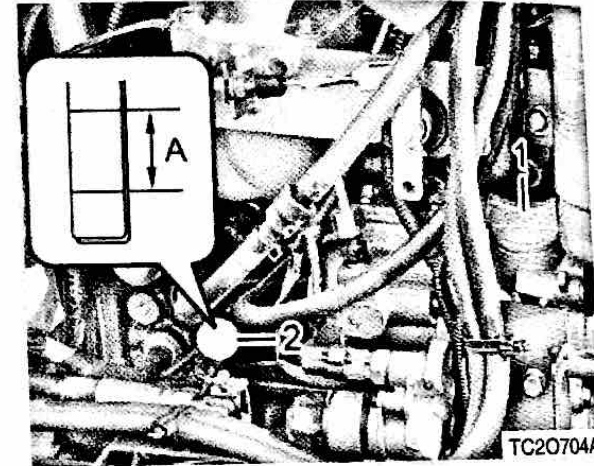

- (1) Oil filler hole (2) Oil dipstick
(A) Oil level is acceptable within this range

1. Park the tractor on a level ground and start the engine to warm it up.

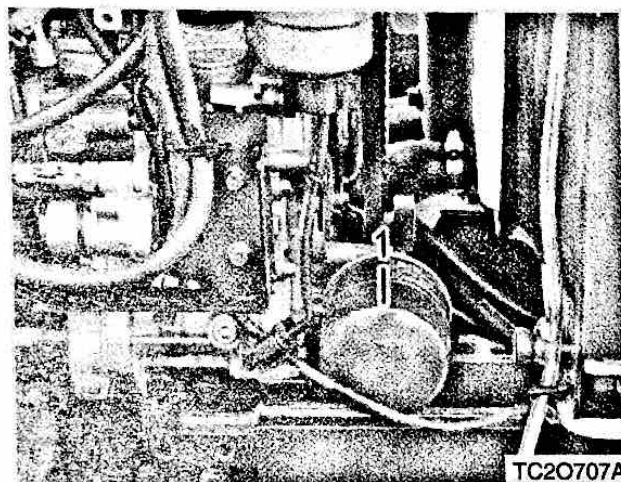
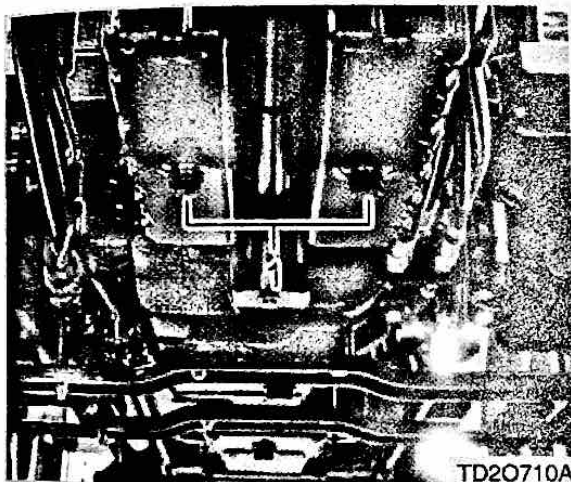

OIL CAPACITY	
EU/AU/TH	1.45 U.S.gal. (5.5 L)
US	1.58 U.S.gal. (6 L)

(1) Drain plug

(1) Engine oil filter

2. Stop the engine, apply the parking brake and remove the drain plug.
3. Wait until the oil is cooled down.
4. Place the oil pan under the engine and unscrew the drain plug counterclockwise to drain the oil completely. All the used oil can be drained out easily when the engine is still warm.

5. Remove the oil filter from the bottom of the fuel filter on the right side of the engine.
6. Apply a thin film of oil to the O-ring of a new filter and tighten the new filter firmly by hand.
7. Fill the engine oil to the specified level and tighten the oil filter to the specified torque.

8. Run the start motor for approx. 10 seconds to distribute oil to each part of the engine.
9. Run the engine for approx. 5 minutes and check for proper operation through the engine oil warning lamp. Then, stop the engine. (It is normal that the oil warning lamp is off while the engine running)
10. Check the engine oil level again with the oil dipstick. If the level is low, add more oil.

 **NOTE**

- The engine oil filter should be replaced when changing the engine oil.

 **WARNING**

- *The engine oil is very hot while the engine is running or right after the engine is stopped. Be careful not to be burnt.*
- *Avoid oil contact while changing or adding engine oil and wear eye protection to prevent eye contact.*
- *Prolonged and repeated contact with the engine oil may cause skin disorders and skin cancer. If skin contact is made, wash thoroughly with soap or hand cleaner as soon as possible.*
- *Keep the used oil out of reach of children.*

 **CAUTION**

To avoid injury:

- **Be sure to stop the engine before changing the fluid or replacing the filter.**
- **Check the engine oil level before every operation of the tractor. If the engine oil is insufficient, the engine can be damaged, and this is not covered by warranty. Be sure to add the engine oil when its level is below the lower limit of the oil dipstick.**
- **Do not dispose of used oil and oil filter into drainage and other places not designated by regulations. Observe applicable regulations when disposing used oil and filters.**

 **IMPORTANT**

- **Use only specified engine oil and KIOTI genuine filter to insure smooth operation and durability of the engine.**

REPLACING TRANSMISSION FLUID AND FILTER (M)

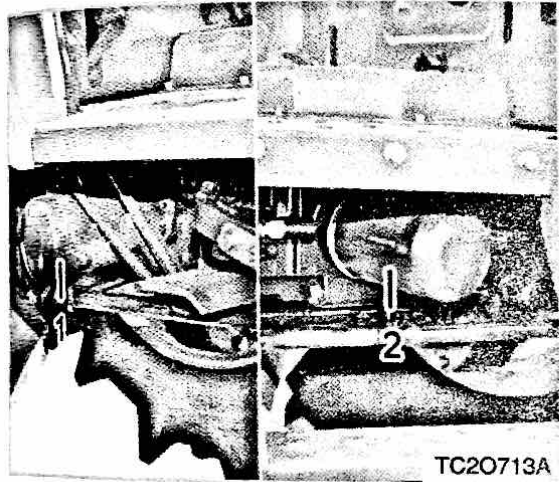

TC2O713A

(1) Hydraulic filter (2) HST filter

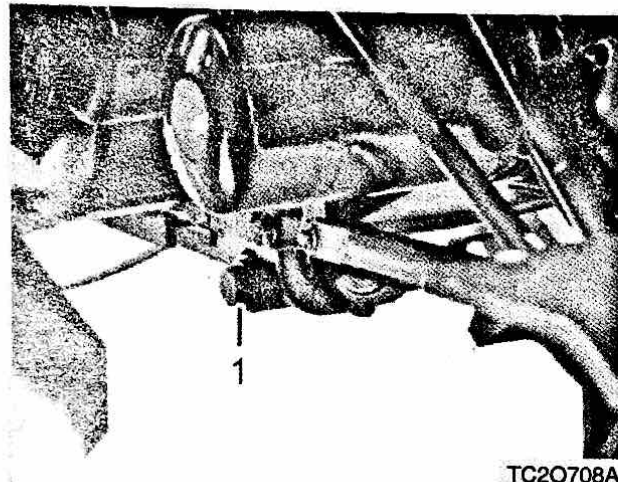

TC2O708A

(1) Drain plug

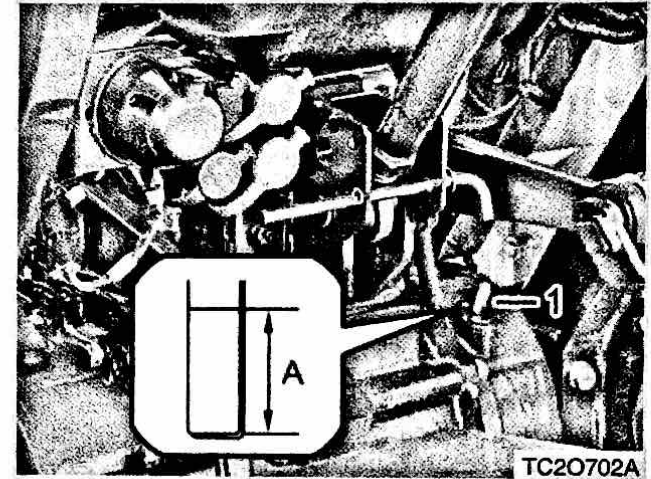

TC2O702A

(1) Oil dipstick and filler port
(A) Oil Level is Acceptable Within This Range

If transmission fluid is contaminated or the transmission is repaired, transmission fluid should be changed. Make sure to replace its filter as well. Also, replace the oil filter at every 200 hours of operation.

1. Park the tractor on a level ground and start the engine to warm it up.
2. Stop the engine, apply the parking brake and remove the drain plug.

3. To drain the used fluid, place a oil container under the transmission case and remove the drain plug to drain used fluid.

If the fluid does not flow out freely, unscrew the breather plug on the side of the hydraulic cylinder on the left of the top link bracket to facilitate drainage. Reinstall the drain plugs securely afterward.

4. Unscrew the fluid filter from the rear right section on the tractor using a filter wrench.

5. Apply a thin film of clean oil onto the O-ring of a new filter.
6. Tighten the filter until it touches the mounting surface. Then, tighten the filter for a half turn further with a hand.
7. After installing a new filter, run the engine for a few minutes and stop it.
8. Check the oil level again and add more oil to the specified level.

OIL CAPACITY

5.81 U.S.gal. (22 L)

CAUTION**To avoid injury:**

- Be sure to stop the engine before changing the fluid or replacing the filter.
- Cool down the fluid sufficiently. You can get burnt by hot fluid.

IMPORTANT

- To prevent serious damage to the hydraulic system, use only a KIOTI genuine filter.
- Do not operate the tractor immediately after changing transmission fluid. Run the engine at medium speed for a few minutes to prevent damage to the hydraulic system.

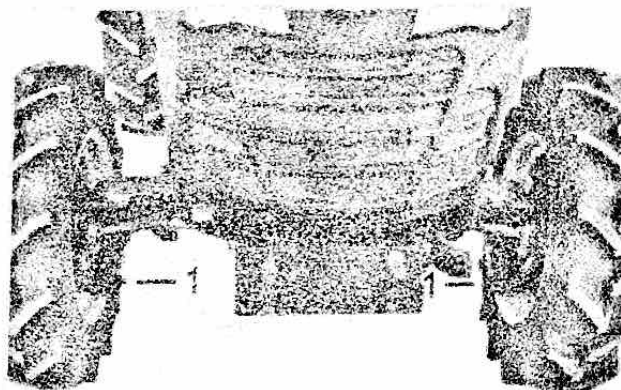
CHANGING FRONT AXLE CASE OIL (N)

TC20709A

(1) Drain plug

1. Remove the drain plugs from the front axle case (LH/RH) and front axle support to drain oil.
2. After draining, reinstall the drain plugs securely.
3. Remove the bleeding plug from the front axle case and add oil through the filler hole.

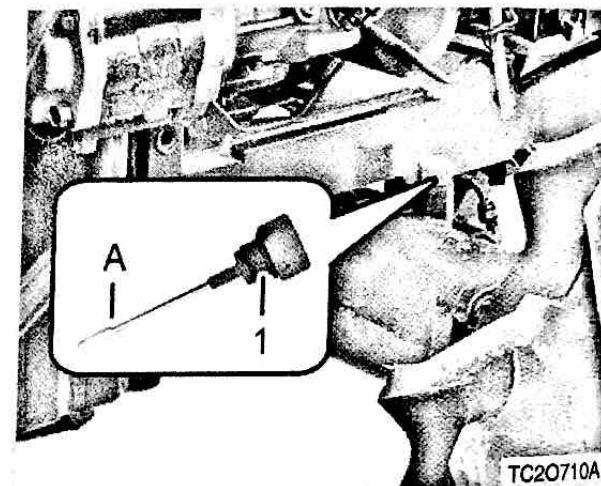

TC20710A

(1) Oil dipstick
(A) Upper Limit

4. Add oil while checking the oil level with the dipstick attached to the filler plug. (Refer to the instructions for the lubrication system in Chapter Maintenance.)
5. After adding oil, fit the filler plug again.
6. Wait for 15 minutes and check the oil level again. If the amount is insufficient, add more oil.

OIL CAPACITY

1.58 U.S.gal. (6.0 L)

ADJUSTING BRAKE PEDAL (O)

Prolonged use of the brake pedal increases its free play. This free play deteriorates the brake performance and can cause a problem to the brake system.

The brake pedal can be adjusted as follows:

1. Release the parking brake.
2. Depress the right brake pedal slightly until some resistance is felt. Then, measure the free play from the top of the pedal.

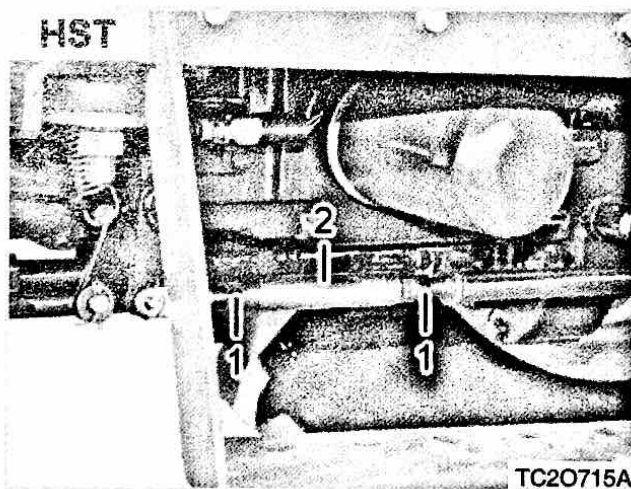
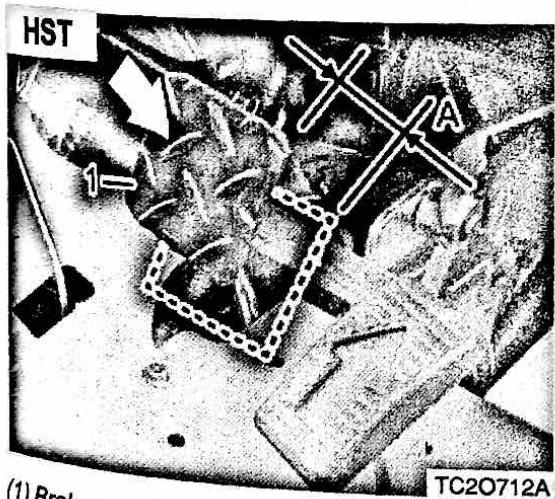
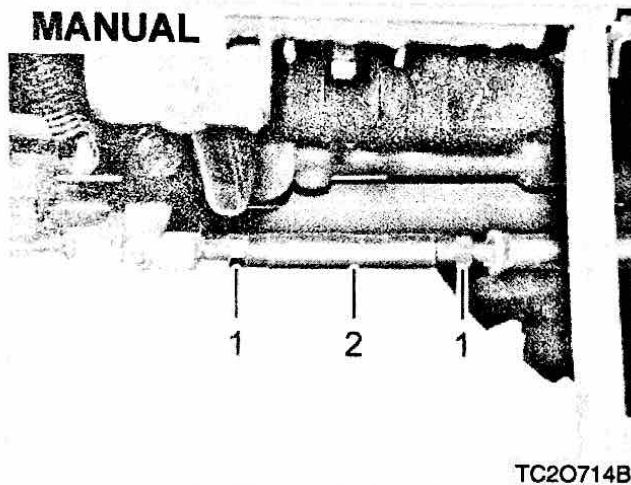
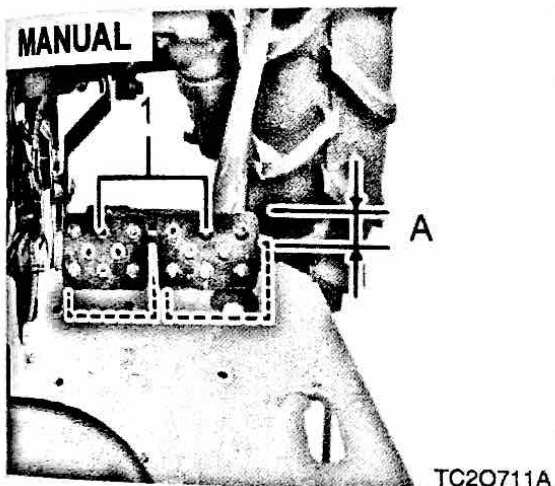

(1) Brake pedal

(A) Free play

(1) Lock nut

(2) Turn buckle

3. When adjustments are needed, loosen the locking nut and turn the turn buckle until the rod length is at the desired and acceptable limit.
4. After adjustment, tighten the locking nut firmly.
5. Repeat the same procedure for the left brake pedal and measure its free play.
6. Interlock the brake pedals after checking or adjusting them.

PROPER BRAKE PEDAL FREE**TRAVEL (A)**

0.8 ~ 1.2 in.
(20 - 30 mm)

**CAUTION**

- **Stop the engine and chock the wheels before checking brake pedal.**
- **Keep the free play in the right and left brake pedals equal.**

LUBRICATING GREASE NIPPLE (P)

Apply quality multi-purpose grease to the locations specified in the following figure at every 50 hours of use or when necessary. Also, record the operating hour on every application.

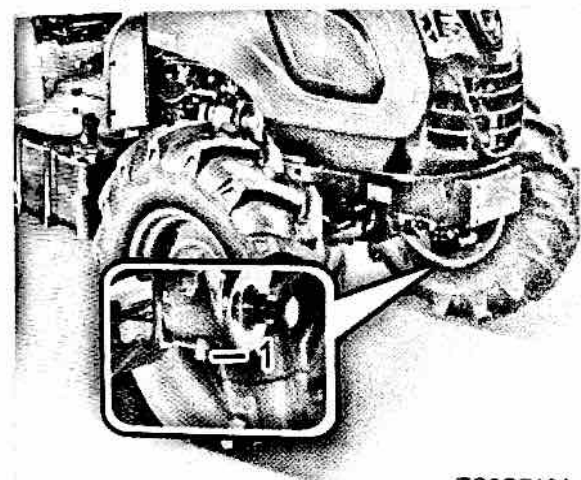

TC20716A

(1) Front bracket (axle pivot)

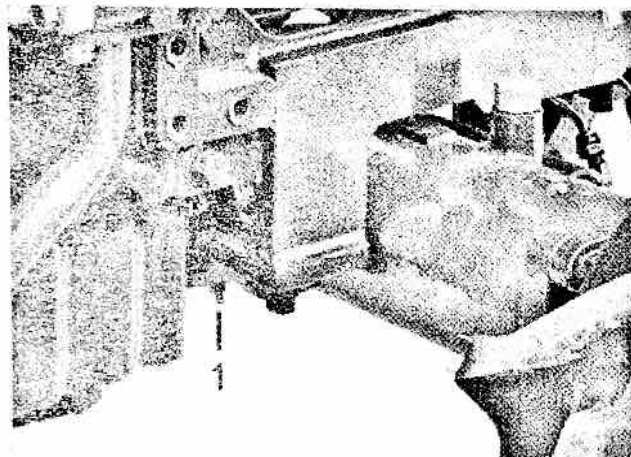

TC20717A

(1) Rear bracket (axle pivot)

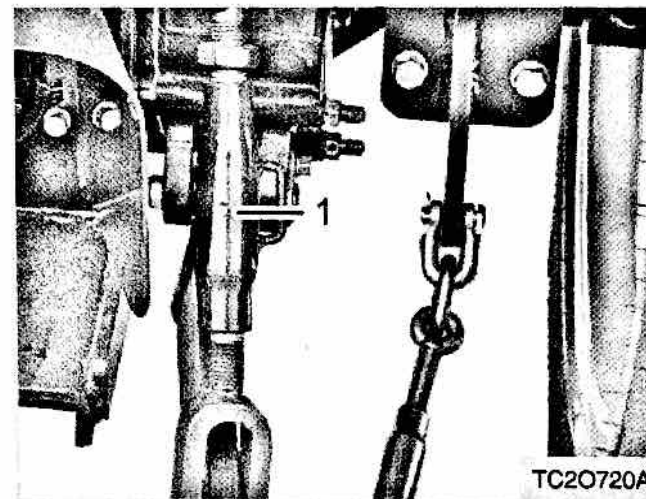

TC20720A

(1) Lift rod

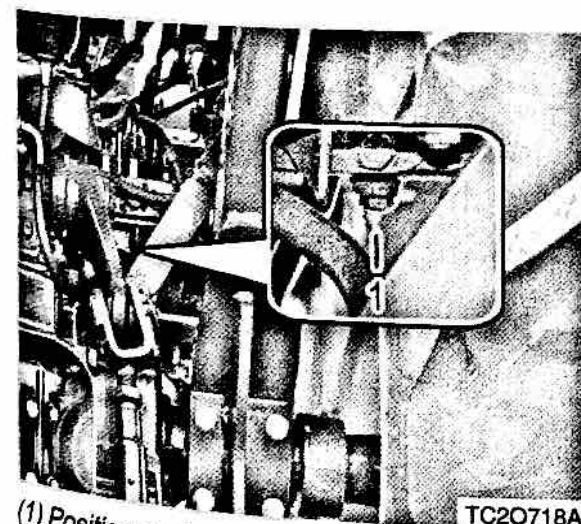

TC20718A

(1) Position control lever shaft housing

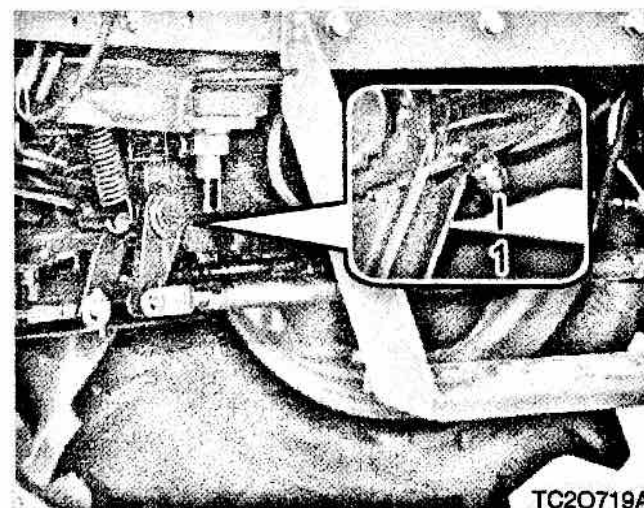

TC20719A

(1) Clutch Pedal

CHECKING WHEEL BOLT/NUT TORQUE (Q)

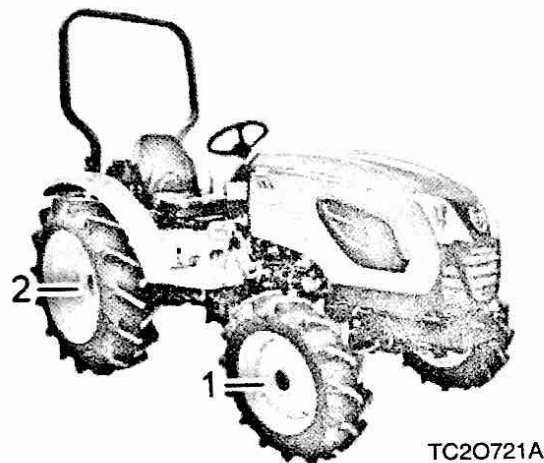

TC20721A

- (1) Front wheel bolt/nut
(2) Rear wheel bolt/nut

Check wheel bolts and nuts regularly especially when new. If they are loose, tighten them as follows.

Item		Tightening torque
Front wheel	Bolt	7.9~9.2 kgf·m 57~67 lbf.ft
	Nut	77~90 N.m
Rear wheel	Bolt	20~23 kgf·m 144~166 lbf.ft
	Nut	196~226 N.m

⚠ CAUTION

To avoid injury:

- Never operate tractor with a loose rim, wheel, or axle.
- Any time bolts and nuts are loosened, retighten to specified torque.
- Check all bolts and nuts frequently and keep them tight.

ADJUSTING CLUTCH PEDAL (R)

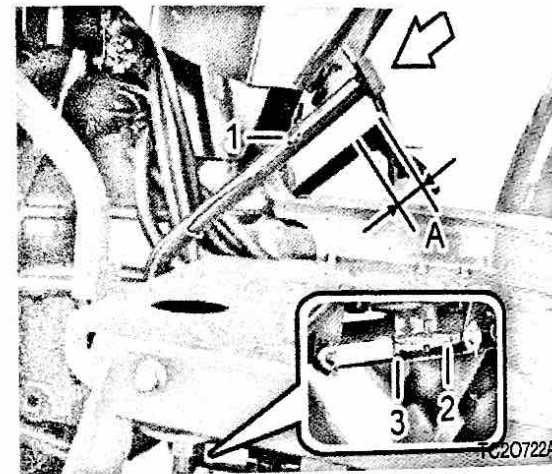

- (1) Brake pedal (2) Clutch rod
(3) Lock Nut
(A) Free Play

1. If the clutch does not operate properly due to its excessive play, adjust its play regularly.
2. To adjust the free play, unscrew its lock nut and adjust the clutch rod.
3. After setting the play properly, tighten the lock nut firmly.

Proper clutch pedal free play (A)

0.8 ~ 1.2 in.
(20 - 30 mm)

FUEL FILTER (S)

REMOVING WATER FROM FUEL FILTER

1. Water and dust in fuel are accumulated in the filter. Remove the plug from the bottom of the fuel filter to drain any impurities.
2. After draining, tighten the plug with a hand. (Do not use a tool.)
3. Start the engine and check for fuel leakage.

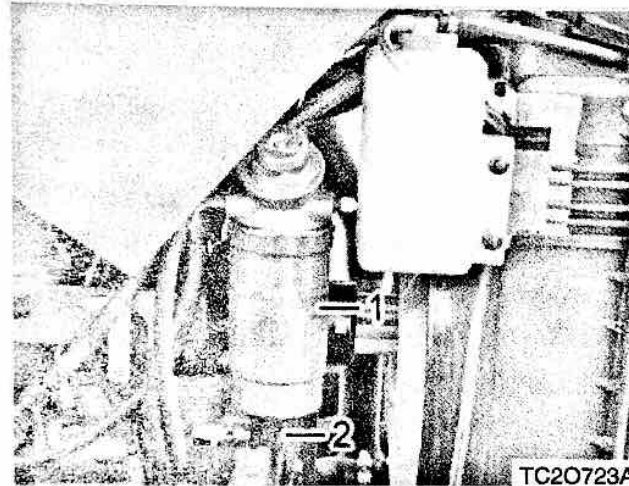

(1) Fuel filter (2) Drain plug

REPLACING FUEL FILTER

1. Wipe the surface of the fuel filter clean.
2. Unscrew the plug on the bottom of the fuel filter to drain fuel.
3. Remove the fuel filter.
4. Remove foreign materials, such as dirt, thoroughly and replace the fuel filter with a new one.

CLEANING AND REPLACING AIR CLEANER FILTER (T)

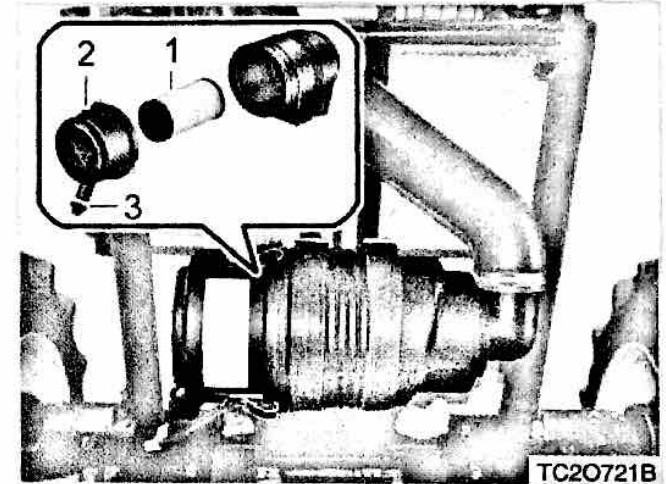

(1) Filter (2) Dust cap
(3) Evacuator valve

1. The air cleaner uses a dry element. Never apply oil.
2. Make sure that dust is not accumulated over the half of the dust cap. Remove the dust cap, wipe out any dust and clean the filter every week. If the tractor is operated in extremely dusty conditions, daily inspection is required.
3. Do not service the filter unless it should be cleaned.

4. For filter replacement, refer to the instruction for replacing the air cleaner filter for every year.

To clean the filter, use only clean dry compressed air on the inside of the filter. Air pressure at the nozzle must not exceed 2 kgf/cm² (29 psi). Maintain reasonable distance between the nozzle and the filter.

⊕ IMPORTANT

- The air cleaner will only fulfill its function if it is correctly and regularly maintained. A poorly maintained air cleaner will mean loss of power, excessive fuel consumption and a reduction in engine life.
- Do not run the engine with filter element removed.

⊕ IMPORTANT

- Be sure to refit the cover with the arrow ↑ (on the rear of cover) upright. If the cover is improperly fitted, the evacuator valve will not function and dust will adhere to the element. (Refer to the instructions for replacing the air cleaner filter for every year in Chapter Maintenance.)

EVACUATOR VALVE

Open the evacuator valve gap by fingers once a week under ordinary conditions or daily when used in dusty conditions to get rid of large particles of dust and dirt.

CHECKING FUEL LINES (U)

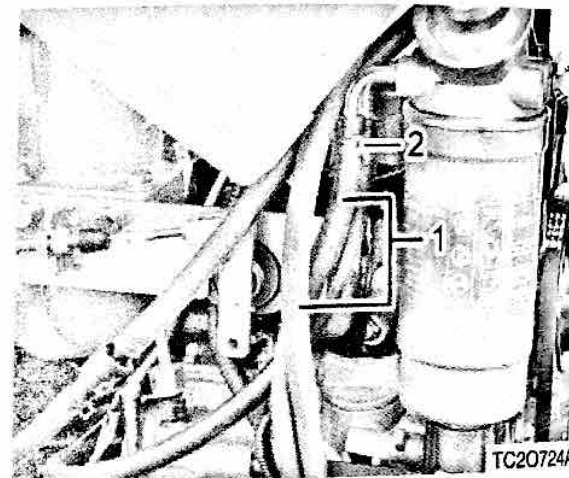

(1) Fuel pipe

(2) Fuel hose clamp

Although checking the fuel pipe connection is recommended every 100 service hours, it should be done every 6 months if operation does not exceed 100 hours in 6 months.

1. If the hose clamps are loose, apply a slight coat of lubricant onto the threads and securely tighten it.
2. The fuel pipe is made of rubber and ages regardless of period of service. Change the fuel pipe together

with the hose clamps every two years and securely tighten.

3. If the fuel pipes and hose clamps are found damaged or deteriorated earlier than two years, then change them immediately.
4. After the fuel pipe and hose clamps have been changed, bleed the fuel system.

⚠ WARNING

- **Stop the engine when checking the items above.**
- **Inspect the fuel pipe regularly. The fuel pipes are subject to wear and aging. Failure to perform periodic inspections may lead to a fuel leak. Fuel leaking on a hot engine could cause a fire.**

⊕ IMPORTANT

- **When disconnecting the fuel pipe for replacement, plug both ends with cloth or paper to prevent dust or foreign material from entering it. Otherwise, the fuel injection pump can be damaged. Pay extra caution to the fuel pump to prevent dust from entering it.**

ADJUSTING FAN BELT TENSION (V)

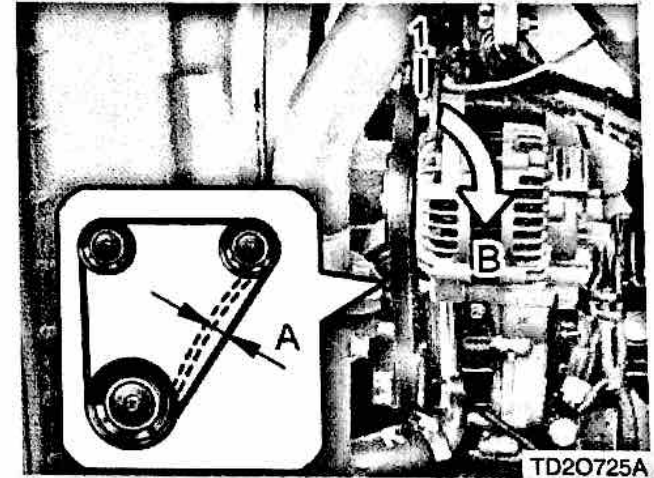

- (1) Adjusting Bolt
 (A) Adjusting Belt Tension
 (B) Pull

In order to extend the fan belt's lifetime, the tension of the belt should be correctly adjusted if it slips. The belt tension should be inspected regularly according to the following procedure:

1. Stop the engine and apply the parking brake.
2. Open the hood.
3. In order to measure the belt tension, apply thumb pressure strongly to the "A" location of belt.

Belt deflection for proper fan belt tension (A)

A deflection of between 0.28 ~ 0.35 in. (7 ~ 9 mm) when the belt is pressed in the middle of the span.

4. If the tension is incorrect, loosen the alternator mounting bolts and, using a lever placed between the alternator and engine block, pull the alternator out until the deflection of the belt falls within acceptable limits.
5. Be sure to retighten the alternator mounting bolt and hinge bolt securely after adjusting belt tension.
6. Replace the fan belt if it is damaged, cracked or worn.

CAUTION



To avoid injury:

- Be sure to stop the engine before checking belt tension.

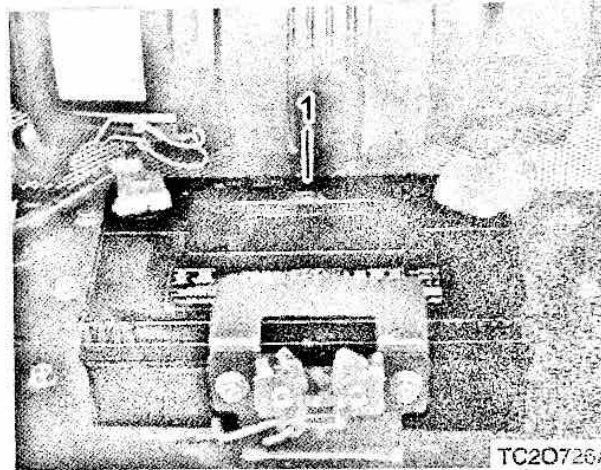
BATTERY (W) PRECAUTIONS FOR HANDLING



(1) Battery

Sight glass	Battery condition
 Blue	Battery normally charged
 Black	Battery discharged, immediate charge required
 White	Replace the battery

Mishandling the battery shortens the service life and adds to maintenance costs. If the battery is insufficiently charged, the headlights may dim and the engine is hard to start. It is important to inspect the battery periodically.

1. The battery cable should always be clean and firmly connected. When installing a new or used battery, clean its terminals.
2. Check the battery and cable for damage and corrosion.
3. Apply grease to the terminals and cable end in order to prevent corrosion.

WARNING

- **The battery gas can explode. Do not expose the battery to flames or sparks. It may cause a fire.**
- **The battery fluid contains sulfuric acid that can burn you. Do not allow the battery fluid to contact your eyes, skin, or painted surfaces. If you accidentally get it in your eyes or on your skin, flush with water and contact your doctor.**
- **Be sure to wear eye protection while working on the battery. The battery fluid can hurt your eyes.**
- **Use only the battery with the specified voltage. Otherwise, it may cause a fire.**

CHARGING

1. To slow charge the battery, connect the battery positive terminal to the charger positive terminal and the negative to the negative, and then recharge in the standard fashion.
2. Boost charging is only for emergencies. It will partially charge the battery at a high rate and in a short time. Failure to do this will shorten the battery's service life.
3. When the battery is discharged and should be replaced, replace it with a new one with same specification and capacity.

BATTERY TYPE	VOLTS (V)
80D26R (80 AH)	12

CAUTION

- **The charge warning lamp comes on if the charging system is defective. If it comes on while driving, have the system checked or repaired by your local KIOTI Dealer.**
- **Keep the battery fully charged. If the battery fluid concentration is too low during the winter season, the battery may be frozen.**
- **Do not start the engine when the battery is frozen. Try to warm it up first.**
- **If the battery is not securely installed, the battery case and electrolytes could be damaged by vibration. To prevent the battery acid from contacting the terminals, apply grease around the battery terminals and connections.**
- **Never check the charge status of the battery by placing a metal object across the posts. Use a voltmeter or hydrometer.**

DIRECTION FOR STORAGE

1. When storing the tractor for a long period, remove the battery from tractor and store in a dry place out of direct sunlight.
2. The battery self discharges while it is stored. Recharge it once every three months in hot seasons and once every six months in cold seasons.

CHECKING INTAKE AIR LINE (X)

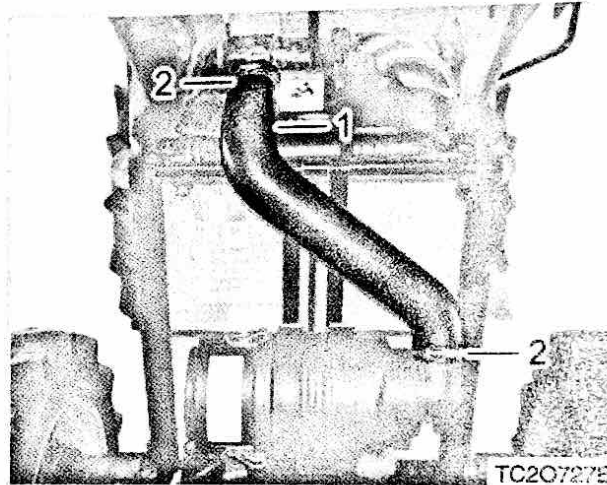

(1) Air line hose

(2) Clamp

1. If the hose clamps are loose, tighten clamps securely.
2. If the hoses and clamps are damaged, you must replace them at once. Failure to do so could lead to engine damage.

ADJUSTING TOE-IN (Y) ADJUSTING PROCEDURE

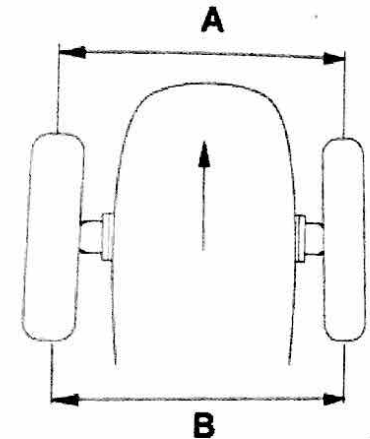

T460A36A

- (A) Wheel - to - wheel distance at front
(B) Wheel - to - wheel distance at rear

1. Park tractor on a flat surface.
2. Turn steering wheel so front wheels are pointed straight ahead.
3. Lower the implement, lock the parking brake and stop the engine.
4. Measure distance between tire beads (center) at front of tire and hub height.
5. Measure distance between tire beads at back of tire and hub height.
6. Front distance should be 2~8 mm (0.079 ~ 0.315 in.) less than rear distance. If not, adjust the length of the tie rod joint.

CHECKING RADIATOR HOSE AND CLAMP (Z)

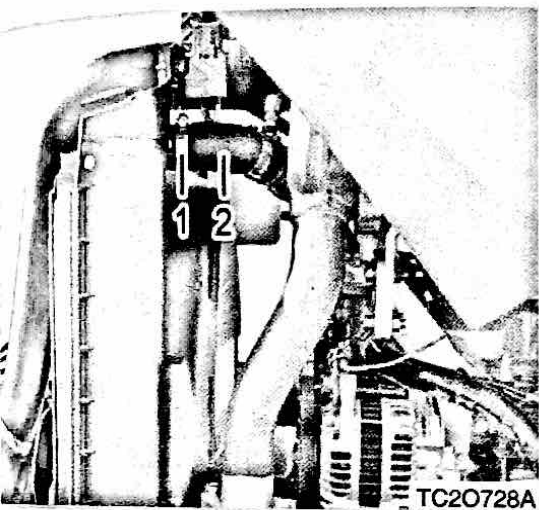

(1) Clamp

(2) Radiator hose

Check to ensure the radiator hoses are free from damage and are tightened properly every 200 hours or every 6 months, whichever comes first.

1. If the hose clamps are loose or water leaks from hose, tighten clamps securely.

2. If the radiator hose is swollen, hardened, cracked or damaged, it should be replaced immediately. Also, it should be replaced every 2 years.

Take the following actions in the event the coolant temperature reaches the boiling point, what is called "Over-heating".

1. Stop the machine in a safe place and keep the engine unloaded idling.
2. After 5 minutes of unloaded idling, shut the engine down.
3. Keep yourself away from the tractor for another 10 minutes or until steam has stopped blowing out of the engine.
4. Make sure that there is no danger and repair the cause of the over-heating according to the manual's instruction. (Refer to the instruction in Chapter. Troubleshooting before starting the engine.)

POWER STEERING LINE (AA)

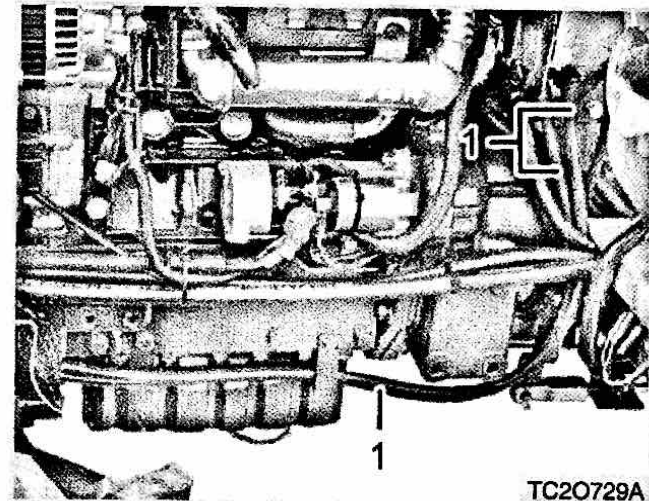

(1) Power Steering Oil Line

1. Check to see that all hydraulic lines and hose fittings are tight and undamaged.
2. If damage is found you should replace the hose or clamp at once.

ADJUSTING FRONT AXLE PIVOT PIN (AD)

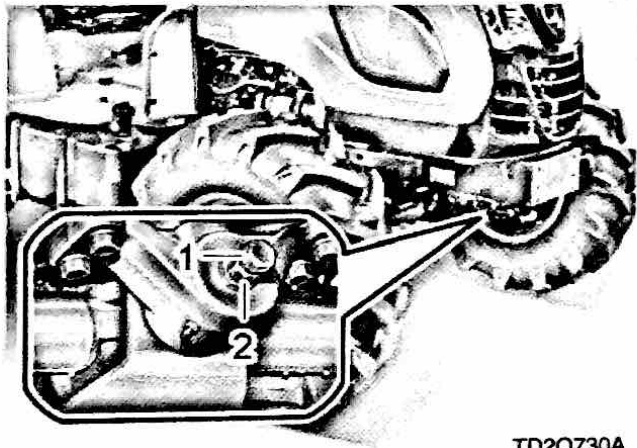

TD20730A

(1) Adjusting screw (2) Lock nut

If the front axle pivot pin adjustment is not correct, front wheel vibration can occur.

ADJUSTING PROCEDURE

Loosen the lock nut, tighten the adjusting screw all the way, and then loosen the screw by 1/6 turn. Retighten the lock nut.

ADJUSTING ENGINE VALVE CLEARANCE (AE)

This service can be affected by the engine sensitively. Therefore, contact your local KIOTI Dealer for this service.

REPLACING AIR CLEANER FILTER (AF)

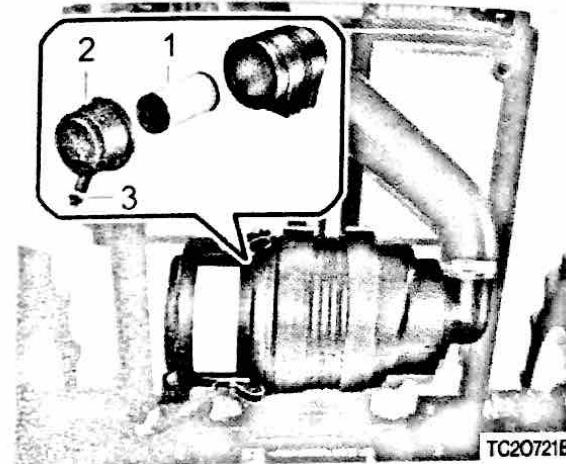

TC20721B

(1) Filter (2) Dust cap
(3) Evacuator valve

If the air cleaner is not in a good condition, the lifetime of the engine can be shortened, excessive soot can be produced, and the engine power can be deteriorated. Therefore, the filter should be inspected frequently. Its replacement interval can be changed according to driving conditions. Replace the filter according to the following procedure:

1. Open the hood and check the suction hose and air cleaner housing for damage.
2. Unscrew the air cleaner clip and remove the cover.
3. Clean the inside of the air cleaner housing thoroughly.
4. Replace the filter and check the housing for damage.
5. Install the cover and fix it with the clip.

NOTE

- When installing the cover, make sure that the dust collection valve is heading down.

CAUTION

- Use only a KIOTI genuine filter. If using a product other than the genuine one, it can damage the engine internal section and sensor.
- Make sure that no dust enters the system by installing the cover firmly.
- When removing the filter, be careful not to let foreign material enter the air inlet.

FLUSH COOLING SYSTEM AND CHANGING COOLANT (AJ)

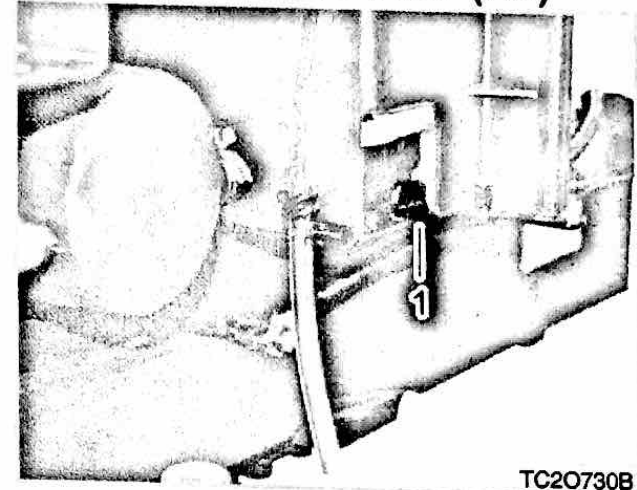

TC20730B

(1) Drain plug

1. Park the tractor on level ground, stop the engine and let the engine cool down.
2. To drain coolant, remove the drain plug from the radiator and turn the radiator cap to the 1st notch to release pressure in the radiator. Then, remove the cap completely.
3. After all coolant is drained, fit the drain plug.

4. Use clean, fresh water and anti-freeze to fill the reservoir tank.
5. Follow the cleaner manufacturer's instruction.

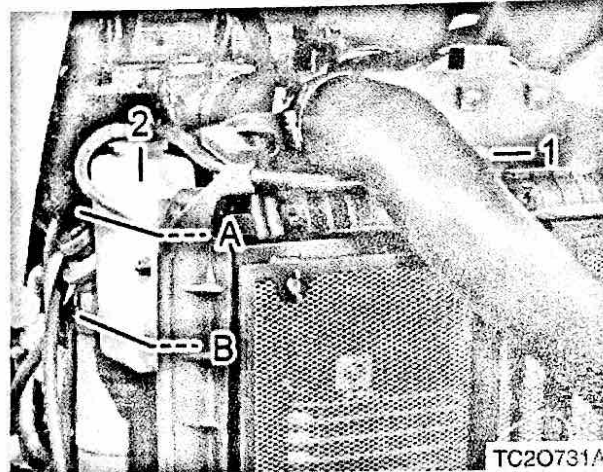

(1) Radiator cap
(A) FULL

(2) Reservoir tank
(B) LOW

6. Install the radiator cap securely.
7. Start and idle the engine for few minutes.
8. Stop the engine and let it cool.
9. Drain water and cooling system cleaner and close drain cock. Then, fill with antifreeze and water mixture and close radiator cap securely.
10. Run tractor at idle until up to operating temperature.

11. Check the coolant level in the reservoir tank. If the level is low, add coolant.

COOLANT CAPACITY	
US	2.72 U.S.gal. (10.3L)
EU / TH	2.64 U.S.gal. (10.0L)

CAUTION

To avoid accidents:

- **Do not remove the radiator cap while the coolant is hot. Steam or scalding liquids released from hot cooling system can burn you seriously. Cool down the engine first.**
- **Even though the coolant is cooled down, turn the cap to its first stop and then wait until it is depressurized before removing the cap completely.**

⊕ IMPORTANT

- Do not start engine without coolant.
- Use clean, fresh water and anti-freeze to fill the radiator and reservoir tank.
- When the anti-freeze is mixed with water, the anti-freeze mixing ratio must be no less than 50% mixture of water and anti-freeze.
- Securely tighten radiator cap. If the cap is loose or improperly fitted, water may leak out and the engine could overheat.
- If the radiator cap has to be removed, follow the caution above and securely retighten the cap.
- Use clean, fresh water and anti-freeze to fill the reservoir tank.
- If the coolant leaks, contact your local KIOTI Dealer.

ANTI-FREEZE

This tractor is filled with 50% of ethylene glycol at factory.

If the anti-freeze has been replaced by tap water later on, the coolant can freeze, leading to damage to the cylinder and radiator when the ambient temperature is below zero (32 °F).

Therefore, make sure to change water into anti-freeze before winter season comes.

When changing the anti-freeze with one of another type, flush the cooling system several times and contact a professional for the mixture ratio.

Anti-freeze % (Ethylene glycol)	Freezing Point		Boiling Point	
	°F	°C	°F	°C
40	-12	-24	222	106
50	-34	-37	226	108

- * At 760 mmHg pressure (atmospheric). A higher boiling point is obtained by using a radiator pressure cap.

NOTE

- The temperatures shown on the left are industry standards that necessitate a minimum glycol content in the concentrated antifreeze.
- When the coolant level drops due to evaporation, add water only. In case of leakage, add anti-freeze and water in the specified mixing ratio.
- Anti-freeze absorbs moisture. Keep unused anti-freeze in a tightly sealed container.
- Do not use radiator cleaning agents when anti-freeze has been added to the cooling water. (Anti-freeze contains an anti-corrosive agent, which will react with the radiator cleaning agent forming sludge which will affect the engine parts)

BLEEDING FUEL SYSTEM (AK)

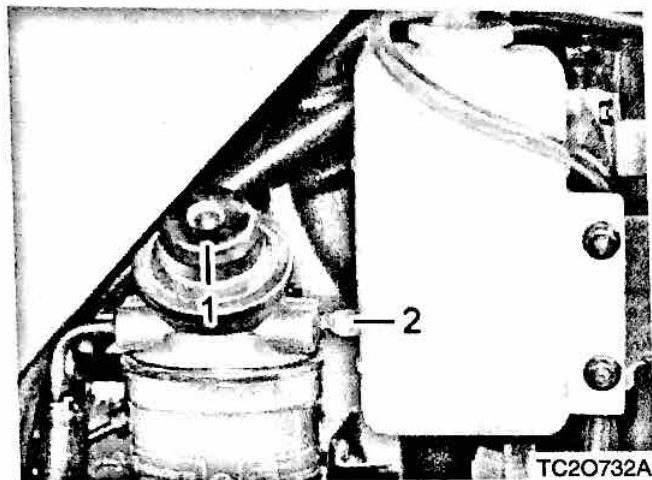

(1) Drive pump

(2) Air plug

1. Make sure that the amount of fuel in the fuel tank is sufficient.
2. If air is introduced into the fuel filter, unscrew the bleeding bolt (2) shown in the above figure, and turn the ignition switch to run the start motor. Then, air in the fuel filter is bled through the bleeding bolt as shown in the figure above.

NOTE

- Bleeding is not necessary if installing the fuel port after fueling.
3. When fuel is visible through the bleeding bolt, tighten the bolt and start the engine.

IMPORTANT

To protect the catalyst filter, keep the followings:

- Make sure to use only genuine fuel.
- Keep the engine oil change schedule.
- Check the engine oil level frequently to keep it to the specified level.
- Avoid any unnecessary engine idling.
- Never stop the engine during driving.
- Never place the shift lever in the neutral position when driving downhill.
- Do not use any engine oil additive or fuel additive.
- Avoid driving with any warning lamp illuminated.
- Do not allow any flammable materials, such as dry grass and paper, to come near the catalyst filter while parked.

⚠ CAUTION

- Never bleed the fuel system while the engine is hot.

⊕ IMPORTANT

- After bleeding, fuel without air bubbles is filtered by the fuel filter and is transferred to the fuel injection pump. Maintain the proper fuel level in the fuel tank before the fuel tank becomes empty. If all fuel is completely consumed in a Diesel engine, fuel should be added to the fuel tank and then the fuel system should be bled.

📖 NOTE

- If the engine cannot be started even after bleeding the fuel system, contact your local Dealer.

DRAINING WATER FROM CLUTCH HOUSING (AL)

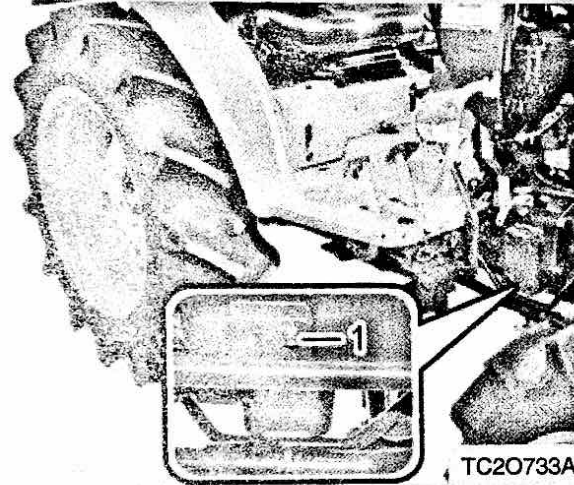

(1) Plug

1. There is a plug under the clutch housing.
2. Drain the water completely and install the plug. Drain the water into a container and dispose of it in a proper manner for environment protection.

BODY FUSE (AN)

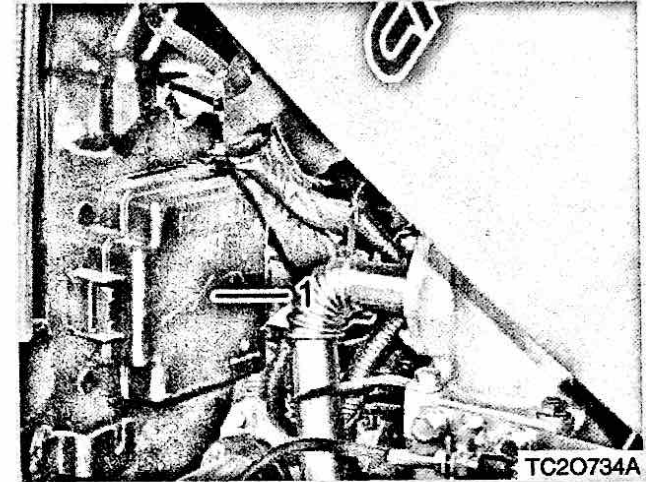

(1) Fuse Box

Fuses protect the tractor electrical system from potential damage. A blown fuse indicates that there is an overload or short somewhere in the electrical system.

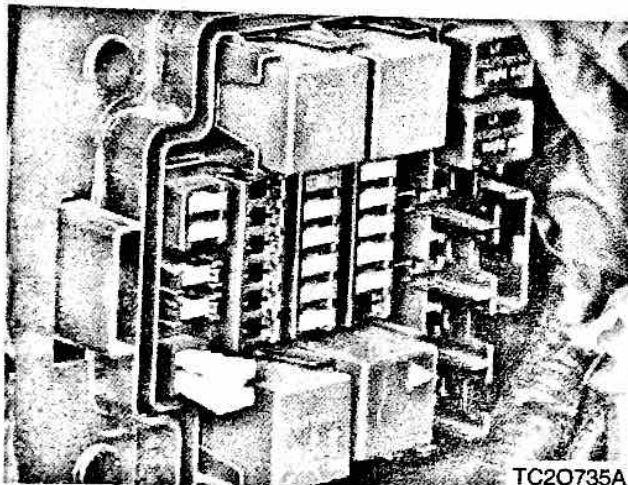

TC20735A

The fuse panel is located in the right section of the engine compartment.

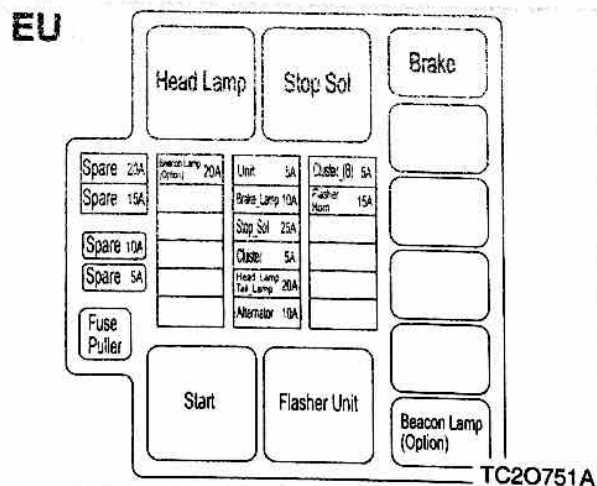
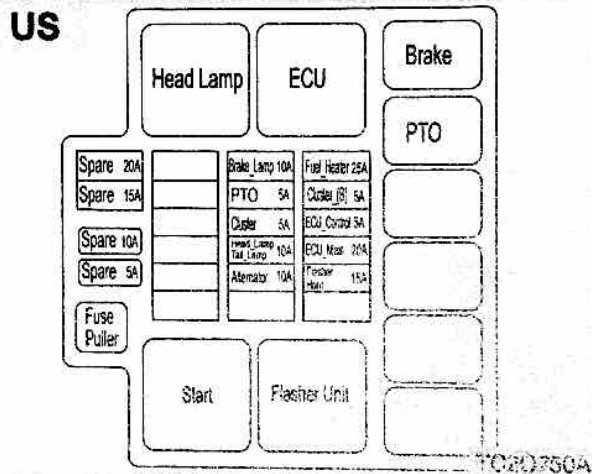

There are marks for the fuse capacity and location on the cover of the fuse panel. Replace the fuse according to the following procedure:

1. Turn the key switch to the "OFF" position and turn off all the electrical devices.
2. Open the fuse box cover and check the fuse in question using fuse tongs.

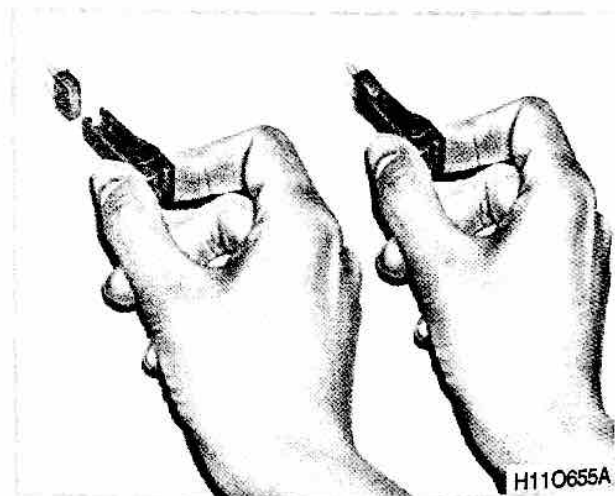

H110655A

3. If the fuse is blown, replace it with a new fuse with same capacity. Make sure it is firmly installed.
4. Install the fuse box cover.

MAIN FUSE (AP)

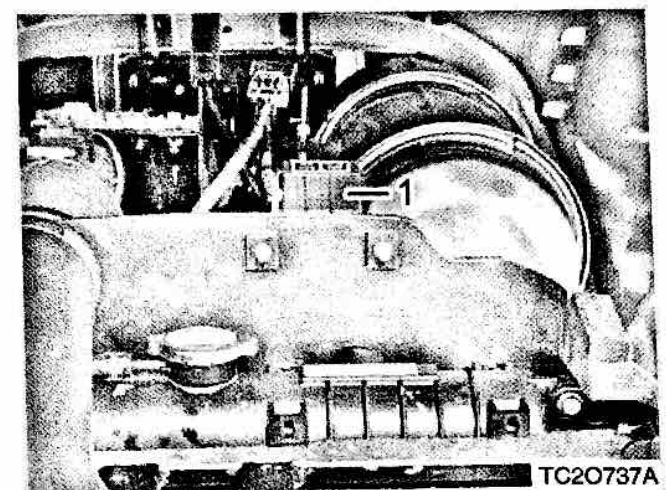

TC20737A

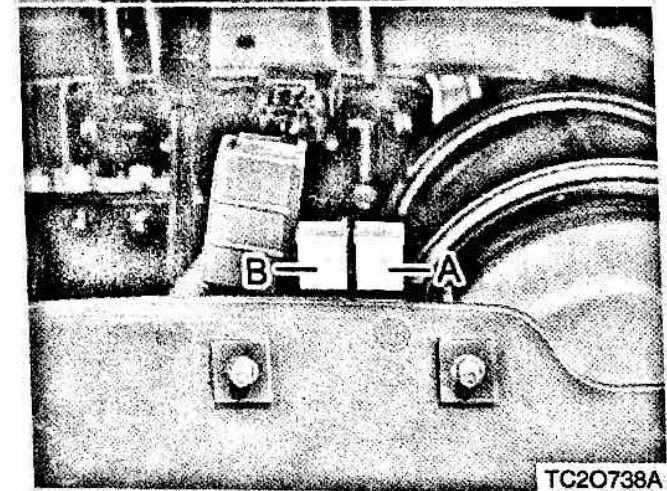

TC20738A

- (1) Main fuse
- (A) Charging power fuse
- (B) Preheating power fuse

⚠ WARNING

- *Never use a fuse with the capacity higher than specified on the fuse box cover.*
- *If using a faulty fuse, steel wire, or foil, the electrical device can be damaged or even can catch a fire.*

📖 NOTE

- *If the replaced fuse is blown soon, it is probable that the wiring system is faulty. In this case, contact your local KIOTI Dealer.*
- *If the fusible link, relay or other electric component is defective, contact your local KIOTI Dealer.*

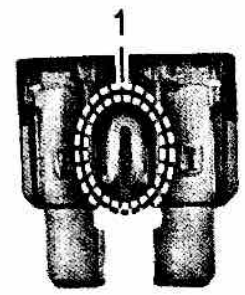

TG10769A

(1) Normal fuse

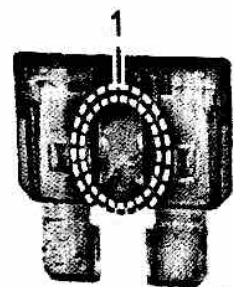

TG10770A

(1) Blown fuse

The main fuse is to protect electric devices and wirings. If the ignition, preheat, charge or main function is faulty, find and move its cause and replace the fuse with a new one.

⊕ IMPORTANT

- Using a non-approved slow-blow fuse can damage electrical systems in the tractor severely.
- Refer to the chapter "Troubleshooting" in this manual or contact your local KIOTI Dealer for specific information dealing with electrical problems.

REPLACING BULB (AQ)

The bulbs and their capacity used in this tractor are listed in the below table. This section only describes procedures the users can handle.

SE- QUENCE	BULB	CAPACITY
1	Headlamp	55W/55W
2	Position lamp (front)	5W
3	Stop/Position lamp (rear)	21W/5W
4	Turn signal lamp	21W
5	Work lamp	21W
6	Rear work lamp	21W

HEADLAMP

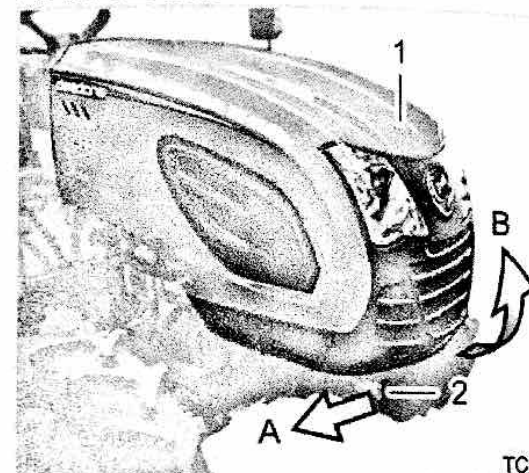

TC20701B

(1) Hood
(A) Pull

(2) Opening knob
(B) Open

1. Turn the key switch to the "OFF" position and open the hood.

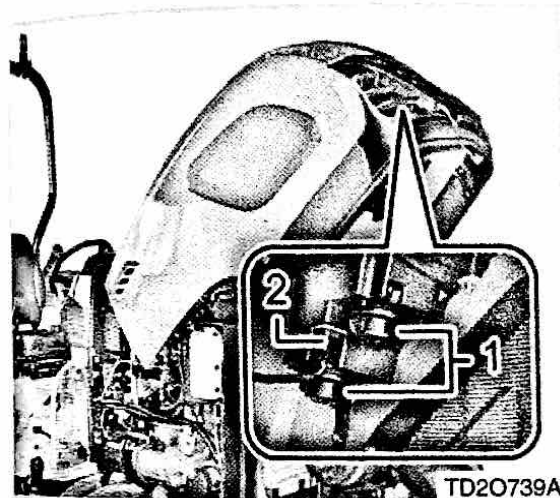

- (1) Cap
 - (2) Connector
2. Remove the cap.
 3. Press and turn the socket counterclockwise to remove the bulb. If the bulb is blown, replace it with a new bulb with the same capacity.

⚠ WARNING

- If using a bulb other than the specified one, the lamp can be damaged and the tractor can even catch fire.
- Make sure to use bulbs with the specified capacity.

⚠ CAUTION

- Make sure to use a KIOTI genuine bulb. Using a non-recommended bulb can cause a fire.
- The headlamps can temporarily be fogged due to rain or car wash. This is because of the temperature difference between the inside and outside of the lamp, which is normal.

REAR TURN SIGNAL LAMP AND POSITION LAMP

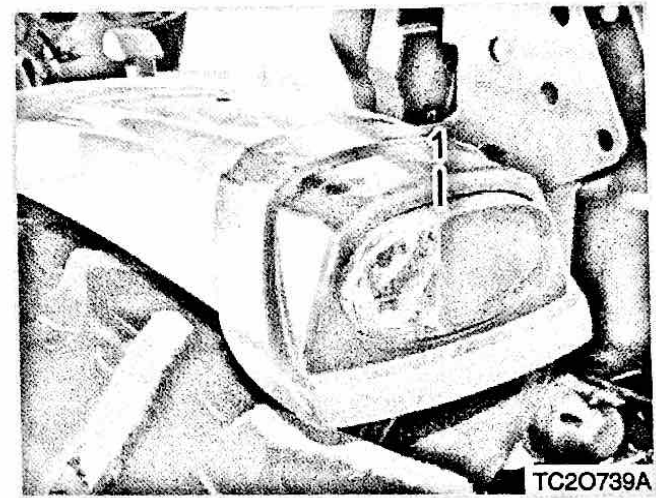

(1) Turn signal lamp

1. The rear turn signal lamps are mounted on the rear fender.

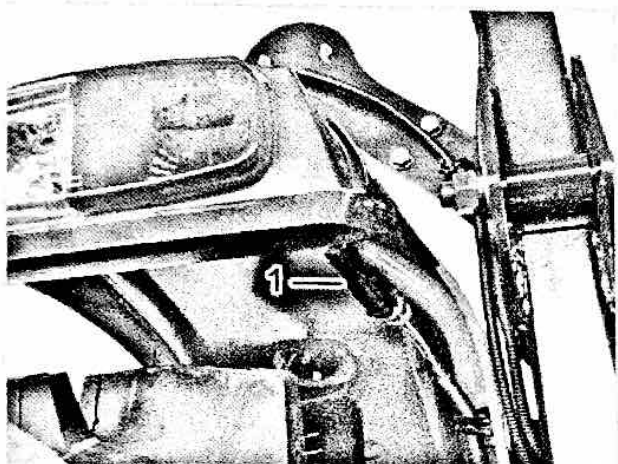

2. Disconnect the connector and loosen the nut from the bottom of the fender to remove the turn signal lamp assembly.

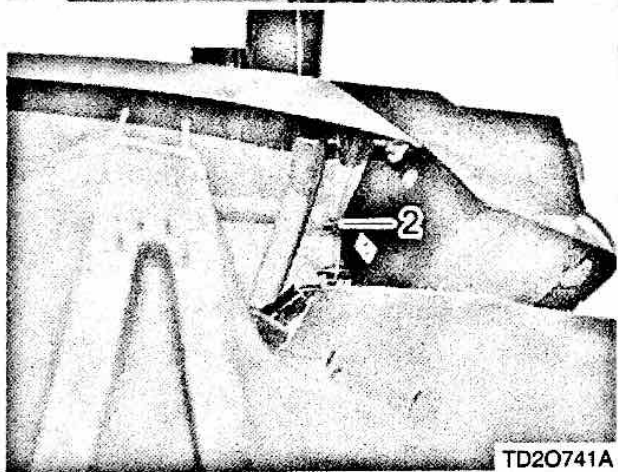

(1) Connector

(2) Nut

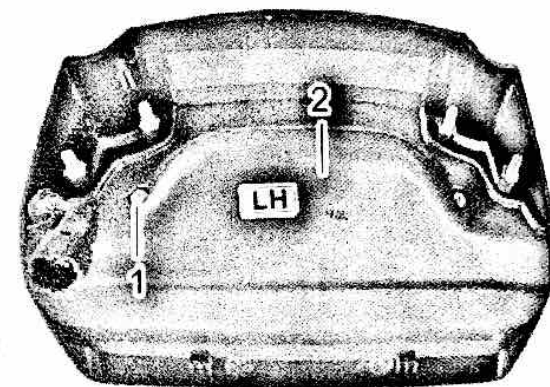

TD20742A

(1) Screw

(2) Cover

3. Loosen the screw to remove the cover.

FRONT TURN SIGNAL LAMP AND POSITION LAMP

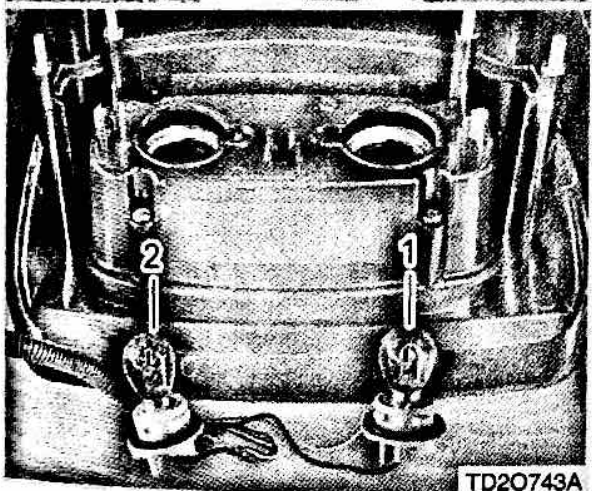
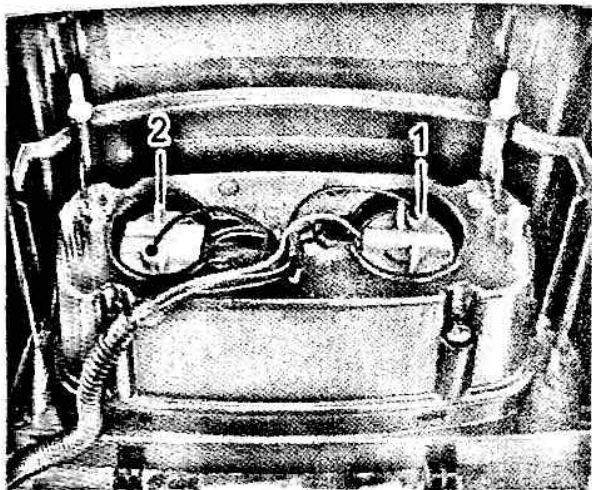

(1) Turn signal lamp (2) Position lamp

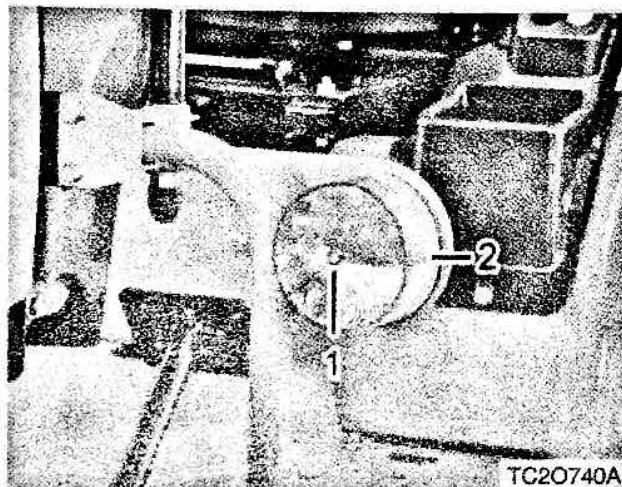

(1) Screw (2) Lens

1. The front turn signal lamps are installed onto the ROPS frame.
2. Loosen the screw to remove the lens.

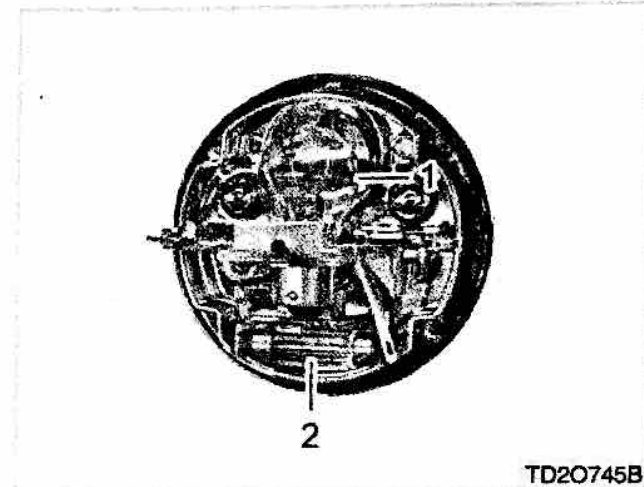

(1) Turn signal lamp bulb
(2) Position lamp bulb

3. Remove the bulb by turning its socket counterclockwise. Install a new bulb.

4. Turn the socket counterclockwise to remove the bulb and replace it with a new one.

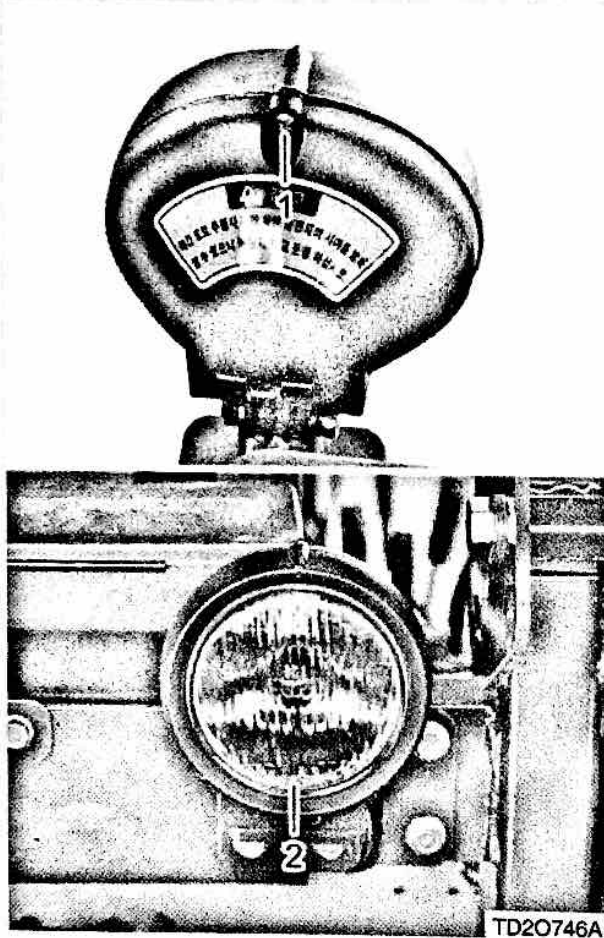
REAR WORK LAMP*(1) Screw**(2) Lens*

1. Loosen the screw to remove the lens.

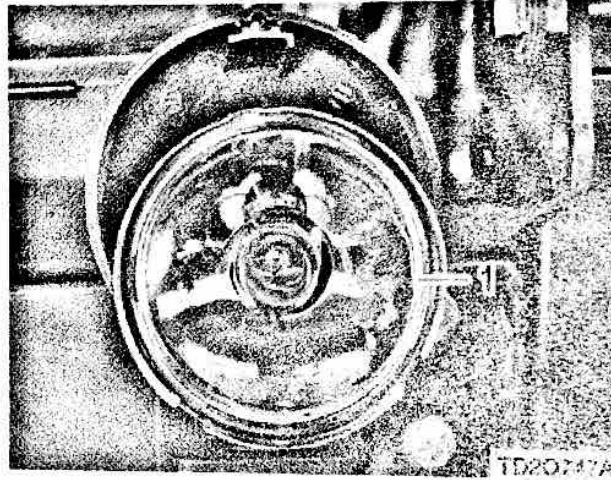
*(1) Bulb socket*

2. Remove the bulb by turning its socket counterclockwise. Install a new bulb.

STORAGE AND DISPOSAL

TRACTOR STORAGE	8-2
DAILY STORAGE	8-2
LONG-TERM STORAGE.....	8-2
USING TRACTOR AFTER LONGTERM STORAGE.....	8-4
USAGE AND DISPOSAL.....	8-4

8

TRACTOR STORAGE

DAILY STORAGE

1. Keep the tractor clean when it is stored. Make sure to wash it after work.
2. Store it indoors if possible. If it should be kept outside, cover it.

WARNING

- *When operating the tractor in an enclosed area, ventilate the area to release exhaust gas to the outside. The exhaust gas is colorless and not visible, but is harmful.*

3. Remove the battery from the tractor in winter and store it indoors.
4. Add anti-freeze to the tractor in winter season in order to prevent the radiator from freezing.
5. Remove the ignition key and store it separately.

LONG-TERM STORAGE

If the tractor will be kept unused for up to 1 year, follow the following instructions. This is to operate the tractor again with minimum preparation after long-term storage. After performing the following instructions, repeat them for the extension period.

IMPORTANT

- **If the tractor is not used for an extended period of time, follow the instructions below to prevent corrosion and performance deterioration of the tractor while it is stored.**

1. Check the bolts and nuts for looseness, and tighten if necessary.
2. Apply grease to tractor areas where bare metal will rust also to pivot areas.
3. Detach the weights from the tractor body.
4. Inflate the tires to a pressure a little higher than usual.

5. Change the engine oil and run the engine to circulate oil throughout the engine parts all for about 5 minutes.
6. Use the clutch locking pin to keep the clutch disengaged. If the clutch is left engaged for a long period of time, the clutch cover may rust, making clutch disengagement impossible at the next operation.
7. With all implements lowered to the ground, coat any exposed area such as hydraulic cylinder piston rods with grease.
8. Remove the battery from the tractor. Store the battery following the battery storage procedures. (See section "Battery" in Chapter Maintenance.)
9. Keep the tractor in a dry place where the tractor is sheltered from rain. Cover the tractor.
10. Clean the engine components as well as the tractor.

11. Add grease to all the grease fitting.
12. Flush the cooling system and drain water from it. Also, add anti-freeze as well as water.
13. Chock the frame in order to remove the weight from the tires.
14. Install the cover to the exhaust pipe.
15. Attach a tag onto the tractor to inform the storage condition of the tractor.
16. If the tractor is equipped with an air-conditioner system, start the engine and activate the air-conditioner system once a month.

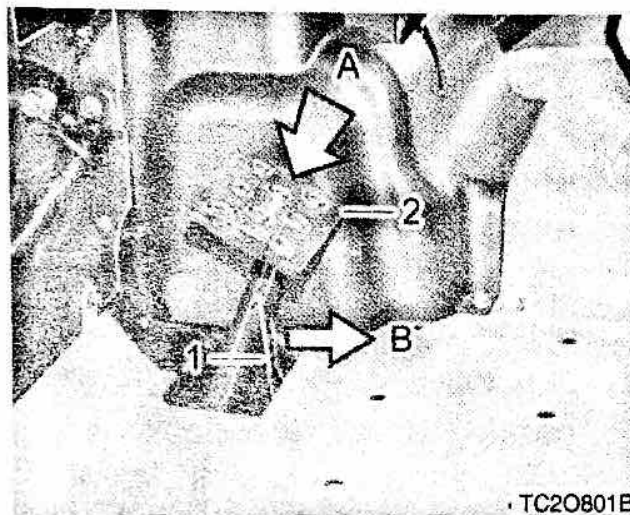

(1) Latch
(A) Depress

(2) Clutch pedal
(B) Pull forward to fix

17. Interlock the brake pedals and apply the parking brake.

CAUTION

To avoid injury:

- Never clean the tractor body while the engine is running.
- Never run the engine in an enclosed area without proper ventilation system in order to prevent poisoning by exhaust gas.
- When storing the tractor, remove the key from the switch and store it separately in order to prevent an unauthorized person from operating the tractor and being injured.
- Cover the tractor after the muffler and the engine have cooled down.
- If the battery is not to be removed, disconnect its negative terminal at least. The wiring can be gnawed by rodents, leading to a fire.

USING TRACTOR AFTER LONGTERM STORAGE

1. Check the tire air pressure and inflate the tires if they are low.
2. Install the battery. Check that the battery is fully charged before installing it.
3. Check the fan belt tension.
4. Check all fluid levels. (Engine oil, transmission/hydraulic oil, and engine coolant)
5. Remove grease from the exposed cylinder rod.
6. Apply grease to the lubrication points.
7. Depress the clutch pedal and undo the latch hook.
8. Get onto the tractor and start the engine.
9. Check if the instrument panel and all parts operate correctly while running the engine for a few minutes.
10. Drive the tractor outside and check if it is operating properly. Park the tractor outside and idle engine for at least 5 minutes. Stop the engine and visually inspect the tractor. Check if there is leakage.
11. Start the engine, release the parking brake and depress the brake pedal to check for its proper condition. Adjust the free play of the brake pedal if necessary.
12. Stop the engine and check for leakage. Repair any part as required.

USAGE AND DISPOSAL

In order to protect the environment, use and dispose of the tractor keeping the following in mind:

1. When changing the oil or coolant by yourself, be careful not to spill it and dispose used oil and coolant properly according to the applicable regulations.
2. Never leave or discard the expired tractor or implement, but contact your local KIOTI Dealer to dispose it according to the regulations.
3. Avoid working under high load as it can cause excessive exhaust gas, which is harmful to the environment.

TROUBLESHOOTING

ENGINE TROUBLESHOOTING 9-2

TRACTOR TROUBLESHOOTING 9-4

This troubleshooting chart summarizes simple service items for users who are familiar with mechanical systems. For more detailed service items, contact your local KIOTI Dealer.

ENGINE TROUBLESHOOTING

Cause		Countermeasures
1. When engine is difficult to start	• Fuel is thick and doesn't flow.	• Check the fuel tank and fuel filter.
		• Remove water, dirt and other impurities.
		• As all fuel will be filtered by the filter, if there should be water or other foreign matters on the filter, replace the filter.
	• Air or water mixed in fuel system.	• If air is in the fuel filter or injection lines, the fuel pump will not work properly.
		• To obtain proper fuel injection pressure, unscrew the fuel cap nut and inspect the system.
		• Loosen air vent screw over fuel filter and fuel injection pump to eliminate all the air in the fuel system.
	• Thick carbon deposits on orifice of injection nozzle.	• This is caused when water or dirt is mixed in the fuel. Clean the injection nozzle and check the fuel filler hole for damage.
		• Check to see if nozzle is working properly or not, if not, install a new nozzle.
• Valve clearance is wrong	• Contact your KIOTI dealer.	
• Engine oil become thick in cold weather and engine cranks slow.	• Change grade of oil according to the weather (temperature).	

Cause		Countermeasures
1. When engine is difficult to start	• Start motor does not rotate when key switch is turned	• Depress the clutch pedal unless depressed.
		• Put the PTO switch to the OFF position.
		• If the switch or start motor is faulty, have it repaired in a workshop.
		• If any terminal is loose or corroded, clean or fix it firmly.
2. When power is insufficient	• Valve out of adjustment	• Contact your KIOTI dealer.
	• Air cleaner is dirty	• Clean or replace the element at every 100 to 200 hours of operation.
	• Fuel injection pressure is wrong	• Contact your KIOTI dealer.
3. When color of exhaust is specially bad	• Fuel is of extremely poor quality	• Select good quality fuel. Temp. Fuel type Over -10°C NO. 2 diesel Below -10°C NO. 1 diesel
	• Nozzle is bad	• If necessary, replace with new nozzle.

* If you have any question, contact your KIOTI Dealer.

TRACTOR TROUBLESHOOTING

Cause		Countermeasures
1. When tractor does not move while engine is running	• Shift lever is in neutral position	• Check the shift levers.
	• Parking brake is applied	• Release the parking brake.
2. Clutch is not operating properly	• Clutch slips (Idles)	• Check and adjust the clutch pedal play. Contact your KIOTI dealer.
		• Faulty clutch pedal position sensor. Contact your KIOTI dealer.
		• Worn hydraulic clutch. Contact your KIOTI dealer.
	• Clutch cannot be disengaged	• Incorrect calibration with clutch engagement. Correct the engagement timing after consulting with your KIOTI Dealer.
		• Check and adjust the clutch pedal play. Contact your KIOTI dealer.
		• Defective hydraulic valve or hydraulic system. Contact your KIOTI dealer.
3. Brake is not operating properly	• Brake does not operate or only one brake pedal operates	• Incorrect calibration with clutch engagement. Correct the engagement timing after consulting with your KIOTI Dealer.
		• The brake pedal play is excessive. Adjust the play.
	• Brake pedal does not return properly	• The brake lining is worn or stuck. Have it replaced in a workshop.
		• The brake return spring is damaged. Replace it.
		• Grease is insufficient on each mating surface. Remove rust and apply grease.

Cause		Countermeasures	
4. Steering wheel is not operating properly	• Steering wheel is heavy or vibrates	<ul style="list-style-type: none"> • The toe-in is incorrect. Adjust it again. • The tire inflation pressure is different. Inflate the left and right tires into the specified pressure. • Each connection is loose. Re-tighten each connection and replace the part. 	
	• Steering wheel play is excessive	<ul style="list-style-type: none"> • The steering wheel shaft is worn. Have it repaired in a workshop. • Metal parts are worn. Have them repaired in a workshop. • Each connection has play. Tighten the connection again. 	
	5. Hydraulic system is faulty	• Oil is leaked from pipe or hose	<ul style="list-style-type: none"> • The pipe clamp is loose. Re-tighten it. • The pipe is cracked. Have it repaired in a workshop.
		• 3-point hitch cannot be lowered	• The valve and cylinder are damaged. Have them repaired at your KIOTI dealer.
		• 3-point hitch cannot be lifted	<ul style="list-style-type: none"> • The transmission fluid is insufficient. Add it to the specified level. • There is air in the intake pipe. Bleed the pipe. • The oil filter is clogged. Clean or replace it. • The hydraulic filter, valve and cylinder are malfunctioning. Have them repaired at your KIOTI dealer.

Cause		Countermeasures
5. Hydraulic system is faulty	• 3-point hitch vibrates by itself	• Defective sensor. Contact your KIOTI dealer.
		• Select the highest top link hole.
6. Electric system is faulty	• Headlamps cannot be turned on or are dim.	• The fuse is blown. Check the wiring and replace the fuse.
		• The bulb is blown. Replace it
		• The ground and terminal wirings are poorly contacted. Check and clean them.
		• The battery electrolyte level is low. Charge the battery.
	• Battery cannot be charged	• Check the battery and alternator.
	• Horn does not sound	• The horn switch is faulty. Replace it.
		• The wiring is faulty. Repair it.
		• The horn is damaged. Repair or replace it.
	• Turn signal lamps do not blink	• The bulb is blown. Replace it.
		• The blinking device is faulty. Repair or replace it.
		• The ground and terminal wirings are poorly contacted. Check and clean them.
	• Work lamps do not come on	• The bulb is blown. Replace it.
• The ground and terminal wirings are poorly contacted. Check and clean them.		

※ If you have any question, contact your KIOTI Dealer.

INDEX

INDEX..... 10-2

710

NUMERIC

3-POINT HITCH CONTROL POSITION CONTROL	5-22
7-PIN SOCKET (OPTIONAL)	4-32

A

ACCELERATOR PEDAL	4-27
ADDITIONAL FRONT WEIGHT	4-39
ADDITIONAL REAR WEIGHT (OPTION)	4-40
ADDITIONAL WEIGHT (OPTION)	4-39
ADJUSTING BRAKE PEDAL (O)	7-19
ADJUSTING CLUTCH PEDAL (R)	7-22
ADJUSTING ENGINE VALVE CLEARANCE (AE)	7-30
ADJUSTING FAN BELT TENSION (V)	7-25
ADJUSTING FRONT AXLE PIVOT PIN (AD)	7-30
ADJUSTING PROCEDURE	7-28
ADJUSTING PROCEDURE	7-30
ADJUSTING TOE-IN (Y)	7-28
ADJUSTMENT OF CHECK LINK	6-5
ADJUSTMENT OF LIFT ROD	6-4
ADJUSTMENT OF TOP LINK	6-5
AFTER DAILY WORK IS COMPLETED	1-30
ANTI-FREEZE	7-33

B

BATTERY (W)	7-26
BATTERY CHARGE WARNING LAMP	4-19
BELTS AND RUBBER PARTS	2-4
BLEEDING FUEL SYSTEM (AK)	7-34
BODY FUSE (AN)	7-35
BRAKE PEDAL	4-25

C

CAUTIONS FOR DECAL MAINTENANCE	1-42
CHANGING ENGINE OIL AND REPLACING FILTER (L) ..	7-14
CHANGING FRONT AXLE CASE OIL (N)	7-18
CHARGING	7-27
CHECK ITEMS	5-2
CHECKING AND ADDING FUEL (C)	7-9
CHECKING BRAKE AND CLUTCH PEDALS (H)	7-14
CHECKING COOLANT LEVEL (F)	7-12
CHECKING ENGINE OIL LEVEL (E)	7-11
CHECKING FUEL LINES (U)	7-24
CHECKING GAUGES, METER AND INDICATORS (I)	7-14
CHECKING HEAD LIGHT, HAZARD LIGHT ETC. (J)	7-14
CHECKING INTAKE AIR LINE (X)	7-28
CHECKING RADIATOR HOSE AND CLAMP (Z)	7-29
CHECKING SEAT BELT AND ROPS (K)	7-14

CHECKING TRANSMISSION FLUID LEVEL (D).....	7-10	DRAINING WATER FROM CLUTCH HOUSING (AL).....	7-35
CHECKING WARNING LAMPS	5-6	DRIVING.....	1-21
CHECKING WHEEL BOLT/NUT TORQUE (Q).....	7-22	DRIVING ON NARROW ROAD, BUMPY ROAD OR SLOPE	1-25
CLEANING AND REPLACING AIR CLEANER FILTER (T)...	7-23	DRIVING ON ROADS	1-24
CLEANING RADIATOR GRILL AND SCREEN (G).....	7-13	DRIVING ON SLOPE	5-17
CLUTCH PEDAL	4-25	DRIVING ON SLOPE	6-11
COMBINATION SWITCH	4-6	DRIVING SPEED TABLE	3-11
COMPONENTS FOR ADDITIONAL FRONT WEIGHT	4-40		
CONNECTING AND DISCONNECTING IMPLEMENT.....	5-28	E	
CONTROLS.....	4-22	ECO PTO	4-12
D		ENGINE COOLANT TEMPERATURE GAUGE.....	4-13
DAILY CHECK ITEM	7-3	ENGINE OIL PRESSURE WARNING LAMP	4-18
DAILY STORAGE.....	8-2	ENGINE SERIAL NUMBER	2-2
DECAL MOUNTING LOCATION.....	1-37	ENGINE TROUBLESHOOTING.....	9-2
DESCRIPTION.....	1-39	ERROR INDICATOR.....	4-21
DIFFERENTIAL LOCK PEDAL.....	4-28	ESSENTIAL REPLACEMENT PARTS	2-3
DIRECTION FOR STORAGE	7-28	EXTERIOR VIEW.....	4-3
DISMOUNTING THE IMPLEMENT	6-5	EXTERNAL DIMENSIONS.....	3-2
DOUBLE ACTING LEVER (OPTIONAL).....	5-26		
DOUBLE ACTING LEVER (OPTIONAL).....	4-31	F	
DPF REGENERATION SWITCH.....	4-8	FILTERS.....	2-4
DPF REGENERATION UNDERWAY LAMP.....	4-15	FIXATION POINTS FOR FRONT END LOADER	6-10
DPF REGENERATION WARNING LAMP.....	4-15	FLUSH COOLING SYSTEM AND CHANGING COOLANT (AJ)	7-31

F

FOR LONG-TERM STORAGE.....1-31

FRONT TIRE SPECS AND WHEEL BOLT/NUT TORQUE ...4-38

FRONT TURN SIGNAL LAMP AND POSITION LAMP7-41

FRONT WHEEL INSTALLATION PATTERN4-38

FUEL FILTER (S).....7-23

FUEL GAUGE4-13

FUNCTION DESCRIPTION AND OPERATING TIPS4-1

G

GENERAL PRECAUTIONS1-2

H

HAND THROTTLE LEVER.....4-27

HANDLING LOADER6-9

HAZARD WARNING FLASHER SWITCH.....4-8

HEADLAMP.....7-38

HEADLAMP SWITCH.....4-6

HITCH (OPTIONAL) AND TRAILER6-6

HORN SWITCH.....4-7

HOW TO DISCONNECT THE HOOD (A)7-9

HOW TO DRIVE.....5-9

HOW TO FOLD ROPS5-13

HOW TO RAISE ROPS TO UPRIGHT POSITION.....5-15

HOW TO WARM UP ENGINE.....5-8

HST CRUISE LAMP (OPTIONAL)4-20

HYDRAULIC BLOCK.....6-12

I

IMPLEMENT LIMITATIONS.....3-13

INFLATION PRESSURE4-35

INITIAL OPERATION.....5-2

INSTALLING AND OPERATING IMPLEMENT.....1-15

INSTALLING PTO SHAFT6-7

INSTRUMENT CLUSTER4-11

INSTRUMENT CLUSTER FEATURES4-11

J

JUMP STARTING.....5-8

K

KEY SWITCH4-5

L

LIFTING ARM (LOWER LINK) SPEED CONTROL KNOB...4-30

LINKED PEDAL LAMP (OPTIONAL).....4-20

LINKED PEDAL LEVER (OPTIONAL)4-32

LOADING AND UNLOADING TO/FROM TRANSPORTING TRUCK	1-28
LOADING INTO AND UNLOADING OUT OF THE TRUCK ..	5-19
LONG-TERM STORAGE	8-2
LUBRICANTS.....	7-8
LUBRICATING GREASE NIPPLE (P).....	7-21

M

MAIN FUSE (AP).....	7-37
MAIN SHIFT LEVER	4-24
MAINTENANCE CHECK LIST	7-3
MAINTENANCE CODE.....	7-9
MAINTENANCE SCHEDULE CHART	7-4
MAJOR SPECIFICATIONS	3-4
MOUNTING LOCATION	4-4

O

OILS AND FLUIDS	2-3
OPERATING THE ENGINE.....	5-3
OPERATING THE TRACTOR	5-9
OPERATION FOR 3-POINT HITCH IMPLEMENT MOUNTING COMPONENTS.....	6-4
OTHER COMPONENTS	2-5

P

PARKING.....	5-15
PARKING BRAKE	4-26
PARKING BRAKE WARNING LAMP	4-19
POSITION CONTROL LEVER	4-30
POWER STEERING LINE (AA)	7-29
PRECAUTIONS FOR HANDLING	7-26
PRECAUTIONS WHEN COMING IN AND OUT OF WORK FIELD.....	5-18
PRECAUTIONS WHEN USING POWER STEERING	5-20
PRECAUTIONS WHILE DRIVING ON THE ROAD	5-18
PREHEAT INDICATOR	4-20
PRE-OPERATION CHECK	5-2
PRODUCTION SERIAL NUMBER.....	2-2
PT1/2 COUPLER SOCKET (IMPLEMENT)	5-27
PTO INDICATOR.....	4-17
PTO SHIFT LEVER.....	4-31

R

RANGE SHIFT LEVER.....	4-24
REAR TIRE SPECS AND WHEEL BOLT/NUT TORQUE ..	4-39
REAR TURN SIGNAL LAMP AND POSITION LAMP	7-39
REAR WHEEL INSTALLATION PATTERN.....	4-38
REAR WORK LAMP.....	7-42

R

REMOTE HYDRAULICS	5-24
REMOVAL AND INSTALLATION OF 3-POINT HITCH IMPLEMENT (INCLUDING CONNECTION OF UNIVERSAL JOINT)	6-2
REMOVING WATER FROM FUEL FILTER.....	7-23
REPLACING AIR CLEANER FILTER (AF).....	7-30
REPLACING BULB (AQ).....	7-38
REPLACING FUEL FILTER.....	7-23
REPLACING TRANSMISSION FLUID AND FILTER (M) ...	7-17

S

SAFETY DECAL MAINTENANCE.....	1-37
SAFETY PRECAUTIONS.....	1-2
SAFETY PRECAUTIONS FOR STORAGE	1-30
SAFETY PRECAUTIONS FOR TRACTOR TRANSPORTATION.....	1-33
SAFETY PRECAUTIONS FOR TRACTOR USE	1-13
SEAT ADJUSTMENT.....	4-29
SEAT BELT.....	4-29
SEAT SLIDING	4-29
SERVICE INSPECTION AND CLEANING	1-7
SINGLE BRAKE LIGHT.....	4-17
SPECIFICATIONS.....	3-2

SPEED CRUISE CONTROL SWITCH (OPTIONAL)	4-10
STANDARD IMPLEMENT DIMENSIONS	3-13
STARTING ENGINE.....	5-3
STARTING THE ENGINE.....	1-13
STOPPING ENGINE	5-7
SWITCHES.....	4-4

T

TACHOMETER/HOURMETER	4-12
TIPS FOR BREAKING-IN.....	5-2
TIRES.....	4-33
TRACTOR STORAGE.....	8-2
TRACTOR TROUBLESHOOTING	9-4
TRANSMISSION NUMBER.....	2-2
TREAD	4-36
TURN SIGNAL LAMP.....	4-14
TURN SIGNAL LIGHT SWITCH.....	4-7
TURNING	5-17

U

USAGE AND DISPOSAL.....	8-4
USING TRACTOR AFTER LONGTERM STORAGE	8-4

V
VEHICLE IDENTIFICATION NUMBER2-2

W
WARMING UP5-7
WATER-IN-FUEL WARNING LAMP4-14
WHEEL INSTALLATION DIRECTION4-38
WHEEL TORQUE AND DIRECTION4-38
WHEN USING LOADER1-34
WORKING IN FIELD1-29



ISO 9001
Certificate
NO. 954596



ISO 14001
Certificate
NO. 771475



OHSAS 18001
Certificate
NO. K033008

ENGLISH / 영문통합

Service Support Division / Daedong Industrial Co., Ltd.

35, Nongongjungang-ro, 34-gil, Nongong-eup, Dalseong-gun, Daegu, Korea 711-711
Tel : 82-53-610-3350 Fax : 82-53-610-3359

<http://www.daedong.co.kr>

Kioti Tractor Division / Daedong-USA, Inc

6300 Kioti Dr, Wendell, NC 27591
Toll Free : 1877 GO KIOTI Tel : 1-919-374-5100 Fax : 1-919-374-5001

<http://www.kioti.com>

Daedong Kioti Europe B.V

Koerilenstraat 2, 3199 LR, Maasvlakte-Rotterdam The Netherlands
Tel: +31 (0)181 35 30 25

<http://www.kioti.eu>



Part # DR70-006

Date of editing : NOV. 2016

Printed in Korea : MAR. 2017